



Electronic Servicing

MOBILE RADIO SERVICING

First of a series, page 54

ES11-469 N-1A 1071
P J BREIDEL
BREIDERS RADIO-TV SVC
1316 S 13TH ST
AA CROSSE WIS 54601

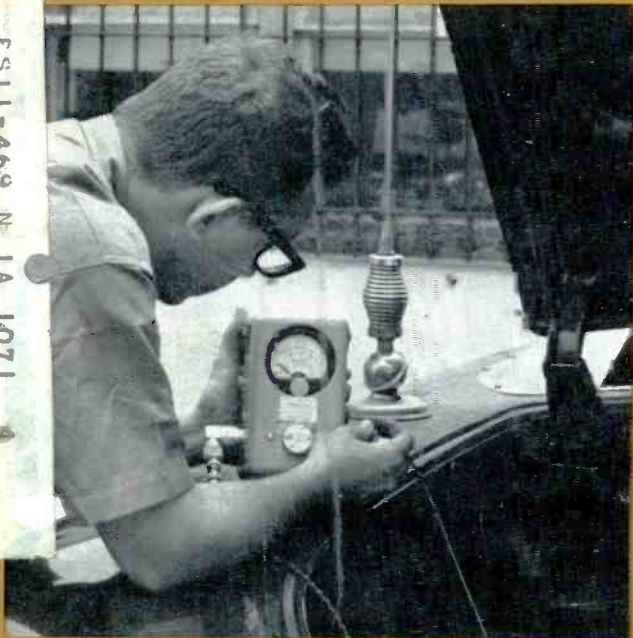

Consumer electronic servicing
is becoming a

'BIG BUSINESS'

see report, page 14

NEA convention agenda, page 51

NEW!
TUN-O-BRITE
 the
 heavy duty
 tuner spray
 with
 built-in
 polishing
 action!



BT-8 8 oz. \$2.39
 BT-16 16 oz. \$3.49

SAVE \$4⁷⁸
WHEN YOU BUY THIS 6-PACK!

AVAILABLE FROM YOUR
 CHEMTRONICS DISTRIBUTOR

SEE THE DIFFERENCE

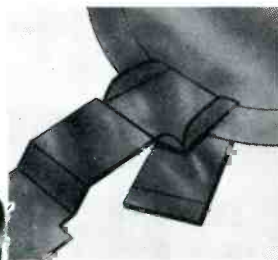

This tuner contact has been sprayed with an ordinary tuner cleaner. It looks clean, but close examination would reveal minute areas with corrosion and dirt.

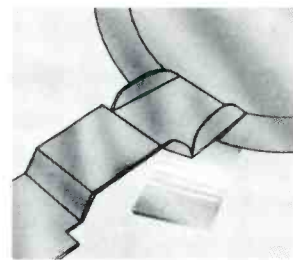

This tuner contact has been sprayed with new TUN-O-BRITE, with its built-in brighteners. It is not only clean, it has been polished shiny. There is absolutely no dirt or corrosion left to spread. What's more, the contact is protected by a film of ultra-long-lasting lubricant.

FEEL THE DIFFERENCE

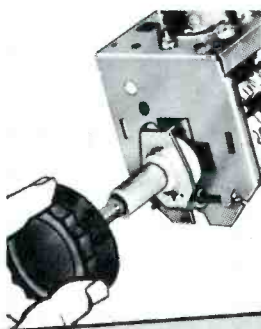

The extra heavy duty lubricant used in TUN-O-BRITE makes any tuner slide from channel to channel smoothly. Your customer will feel the difference immediately. When he sees bright, clear pictures on every channel and feels how smoothly the channels change, he'll know you've done something almost miraculous to his tuner.



CHEMTRONICS INC. 1260 RALPH AVENUE
 BROOKLYN, N. Y. 11236

Circle 1 on literature card



Our hot ones are the last to go.

The last thing you need is to be called back a day or two after you've replaced the sweep or high voltage tubes in somebody's color TV.

But, they're usually the first to go. Because they get so hot.

So we figured out how to cool them. Now, they last a lot longer.

Take our 6JE6C/6LQ6, for example. It's the horizontal deflection tube that takes such a beating when the set gets hot.

Well, we've given it special patented radiator fins that first absorb the heat and then radiate it out of the tube.

Now it runs cooler and lasts longer. Same for our 6JS6C.

Or take our 6BK4C/6EL4A. That's the shunt regulator that eliminates runaway high voltage. We gave this one a whole new anode and shield design to improve heat transfer and stability.

Circle 3 on literature card

Now it also runs cooler and lasts longer.

Or take our 3A3B high voltage rectifier. This one's got leaded glass for added protection. And it lasts longer too.

So next time you have to replace any of the hot ones, just cool it. You'll both last longer.

SYLVANIA
GENERAL TELEPHONE & ELECTRONICS

Electronic Servicing

Formerly PF Reporter

14 Consumer Electronic Servicing—A Look at Where It's Heading. Traditional "ma and pa" operations become fewer and receive less of total annual dollar volume as electronic servicing evolves into "big business" businesses. **by J. W. Phipps.**

18 Step-by-Step Operation of a Triggered-Sweep Scope. How to set up a triggered scope for measurements of sine and complex waveforms. **by Robert G. Middleton.**

24 Dale's Service Bench—Servicing the Automatic Turntable. Part 1 of a two-part series that acquaints you with a logical and time-saving system of troubleshooting the mechanical portion of today's phonographs, plus a brief refresher on theory of operation. **by Allan Dale.**

36 Shop Talk—Selecting Replacement Resistors. ELECTRONIC SERVICING's technical editor reviews the characteristics of resistors and other factors that must be considered to assure proper resistor replacement. **by Carl Babcoke.**

44 Isolating Distortion In Stereo Systems. Analysis of the common causes of harmonic, intermodulation, crossover, amplitude and other forms of distortion, plus proven techniques for quickly finding them. **by Leonard Feldman.**

51 National Electronic Associations' Convention Agenda. Timetable and costs of business and recreational events at the upcoming NEA annual convention in St. Louis, July 15-19.

54 Mobile Radio Servicing. This first installment of a three-part series provides fundamental facts about servicing mobile radio—what it involves and what you need to get into it. Parts 2 and 3 cover troubleshooting techniques and proof-of-performance tests, respectively. **by Leo G. Sands.**

DEPARTMENTS

Electronic Scanner	4	Troubleshooter	40
Letters to the Editor	8	Book Reviews	43
Service Training Schedule. 17		PHOTOFACT Bulletin	52
Symcure	32	Advertisers' Index	62
Test Equipment Report	34	Product Report	62
Audio Systems Report	39	Catalogs and Literature	64

Second class postage paid at Kansas City, Mo. and additional mailing offices. Published monthly by INTERTEC PUBLISHING CORP., 1014 Wyandotte St., Kansas City, Mo. 64105, Vol. 20, No. 6. Subscription rates \$5 per year in U.S., its possessions and Canada; other countries \$6 per year.

Copyright, 1970, Howard W. Sams & Co., Inc. All rights Reserved. Material may not be reproduced or photocopied in any form without written permission of publisher.

EDITORIAL

GEO. H. SEFEROVICH, Director
 J. W. PHIPPS, Managing Editor
 CARL BABCOKE, Technical Editor
 MARY M. SYMON, Editorial Assistant
 DUDLEY ROSE, Art Director

CONTRIBUTING AUTHORS

Bruce Anderson
 Allan Dale
 Robert G. Middleton

TECHNICAL CONSULTANT

JOE A. GROVES

EDITORIAL ADVISORY BOARD

LES NELSON, Chairman
 Howard W. Sams & Co., Indianapolis

CIRCULATION

ROBERT M. CURRY, Director
 EVELYN ROGERS, Manager

ADVERTISING SALES

Kansas City, Missouri 64105
 Tele: 913/888-4664
 E. P. LANGAN, Director
 R. JACK HANCOCK, Manager
 JAKE STOCKWELL
 S. F. WILSON, Production

REGIONAL ADVERTISING SALES OFFICES

Indianapolis, Indiana 46280
 ROY HENRY
 2469 E. 98th St.
 Tele: 317/846-7026

New York, New York 10019
 CHARLES C. HORNER
 3 W. 57th St.
 Tele: 212/688-6350

Los Angeles, California 90005
 JOHN D. GILLIES
 3600 Wilshire Blvd., Suite 1510
 Tele: 213/383-1552

London W. C. 2, England
 JOHN ASHCRAFT & CO.
 12 Bear Street
 Leicester Square
 Tele: 930-0525

Amsterdam C. Holland
 JOHN ASHCRAFT & CO.
 W.J.M. Sanders, Mgr.
 for Benelux & Germany
 Herengracht 365
 Tele: 020-240908

Tokyo, Japan
 INTERNATIONAL MEDIA
 REPRESENTATIVES LTD.
 1, Shiba-Kotohiracho, Minatoku
 Tele: 502-0656



ELECTRONIC SERVICING (with which is combined PF Reporter) is published monthly by Intertec Publishing Corp., 1014 Wyandotte Street, Kansas City, Missouri 64105.

Subscription Prices: 1 year—\$5.00, 2 years—\$8.00, 3 years—\$10.00, in the U. S. A., its possessions and Canada.

All other foreign countries: 1 year—\$6.00, 2 years—\$10.00, 3 years—\$13.00. Single copy 75¢; back copies \$1.



Robert E. Hertel, Publisher

Intertec Publishing Corp.
 Subsidiary of Howard W. Sams & Co., Inc.

Do you want the
same things
Dick DeVroeg wants in capacitors?

Then you'll ask for
Sprague Twist-Lok[®] Capacitors when
you need twist-prong electrolytics.

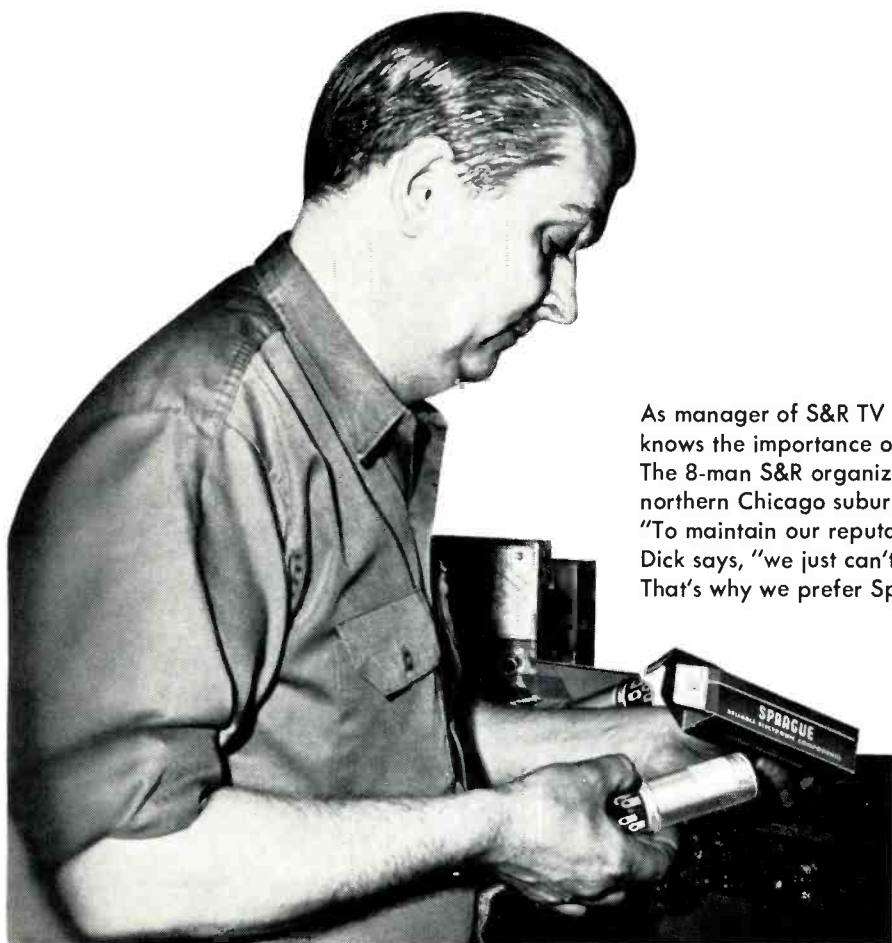

As manager of S&R TV in Lake Forest, Illinois, Dick DeVroeg knows the importance of using quality components. The 8-man S&R organization has built a name for itself in northern Chicago suburbs over the past 18 years. "To maintain our reputation in servicing everything in electronics," Dick says, "we just can't compromise on dependability. That's why we prefer Sprague Twist-Lok Capacitors."

Ask your Sprague distributor for a copy of Sprague's Electrolytic Capacitor Replacement Manual K-109 or write to: Sprague Products Company, 105 Marshall St., North Adams, Mass. 01247.

P.S. You can increase your business 7½% by participating in EIA's "What else needs fixing?" program. Ask your distributor or write to us for details.

Circle 4 on literature card



NEW COAX UHF & VHF

MATCHING TRANSFORMER

INPUT-SPLITTER

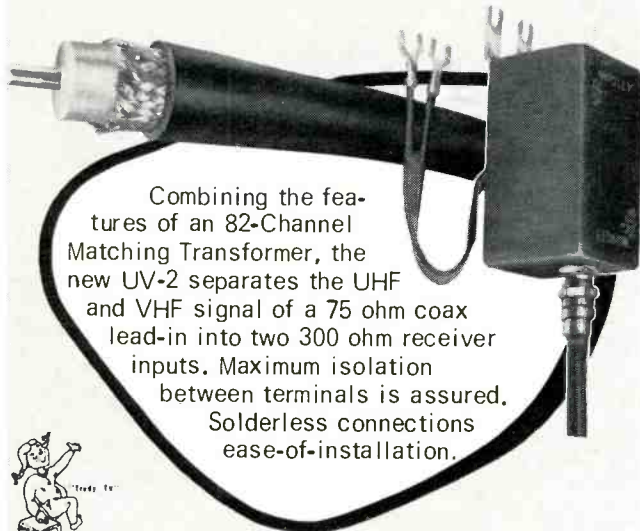

Combining the features of an 82-Channel Matching Transformer, the new UV-2 separates the UHF and VHF signal of a 75 ohm coax lead-in into two 300 ohm receiver inputs. Maximum isolation between terminals is assured. Solderless connections ease-of-installation.



Write Dept. 168 for FREE detailed brochure

Mosley Electronics Inc. 4610 N. Lindbergh Blvd.,
Bridgeton Missouri 63042

Circle 5 on literature card

GOZINTA®

A NEW TOOL FOR CLEANING
CONTROLS OF TV AND AUTO RADIOS
THRU FRONT PANELS



MODEL NO. WJL
PACKAGED WITH 3 OZ. AEROSOL
LUBRITE. DEALER COST \$2.67

MANUFACTURED BY
WORKMAN Electronic
SARASOTA FLORIDA PRODUCTS INC.

Circle 6 on literature card

electronic scanner

news of the industry

RCA Inboard Warranty Labor Nationwide in Year

RCA will expand its inboard warranty labor program nationwide within a year, possibly by Jan. 1, 1971, according to a recent report in **Merchandising Week (MW)**.

This information reportedly was obtained by the **MW** editorial staff while covering the closed-door manufacturer-dealer relation sessions at the 1970 convention of the National Alliance of Retail Dealer Associations (NARDA), held in the Grand Bahama Islands in April.

RCA has been conducting pilot tests of inboard warranty labor in Indianapolis and on the West Coast.

Motorola Bows Out of Color CRT Business

Motorola's color picture tube manufacturing facility in Franklin Park, Ill., has been closed down and the machinery, equipment and some other assets sold to General Telephone & Electronics International Corporation, parent company of Sylvania.

The "depressed color TV market" was given as the reason for Motorola's withdrawal from color CRT manufacturing.

Sylvania Introduces Solid-State High-Voltage Unit For Color TV

A solid-state, high-voltage multiplier, designed to replace tube-type, high-voltage sections in color TV



receivers, has been developed by Sylvania Electric Products Inc.

The solid-state assembly, shown here, reportedly consists of diodes and capacitors in an epoxy enclosure, and operates without an external shunt regulator tube.

Vertical Interval Reference Signals Being Tested For Possible Improvement of Color Uniformity

Better color uniformity on home color television receivers might be achieved through use of Vertical Interval Reference signals by broadcast stations, if ex-

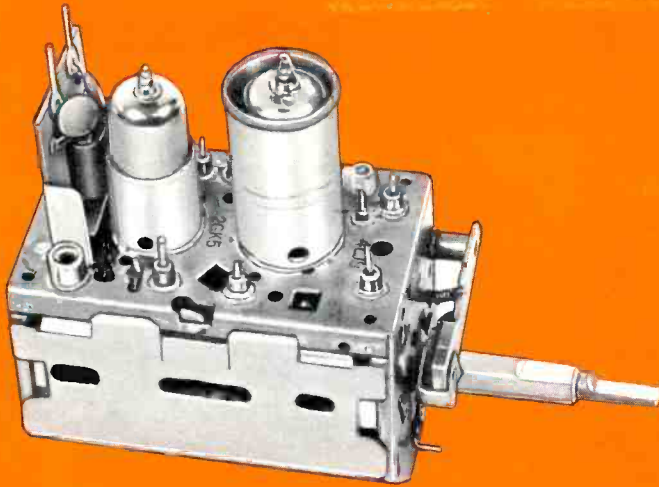

\$975

TUNER SERVICE CORPORATION

PROVIDES YOU WITH A COMPLETE SERVICE FOR ALL YOUR TELEVISION TUNER REQUIREMENTS AT ONE PRICE.

TUNER REPAIR

VHF Or UHF Any Type \$9.75.
UHF/VHF Combo \$15.00.

In this price all parts are included. Tubes, transistors, diodes, and nuvistors are charged at cost.

Fast efficient service at our 4 conveniently located service centers.

1 year guarantee backed up by the largest tuner manufacturer in the U.S.—SARKES TARZIAN INC.

All tuners are cleaned inside and out, repaired, realigned and air tested.

TUNER REPLACEMENT

Replacement Tuner \$9.75.

This price buys you a complete new tuner built specifically by SARKES TARZIAN INC. for this purpose.

The price is the same for every type of universal replacement tuner.

Specify heater type

Parallel 6.3V
Series 450 mA
Series 600 mA

All shafts have the same length of 12".

Characteristics are:

Memory Fine Tuning
UHF Plug In
Universal Mounting
Hi-Gain Lo-Noise

If you prefer we'll customize this tuner for you. The price will be \$18.25. Send in original tuner for comparison purposes to our office in INDIANAPOLIS, INDIANA.



TUNER SERVICE CORPORATION

FACTORY-SUPERVISED TUNER SERVICE

MIDWEST 817 N. PENNSYLVANIA ST., Indianapolis, Indiana TEL: 317-632-3493
(Home Office)
EAST 547-49 TONNELE AVE., Jersey City, New Jersey TEL: 201-792-3730
SOUTH-EAST 938 GORDON ST., S. W., Atlanta, Georgia TEL: 404-758-2232
WEST SARKES TARZIAN, Inc. TUNER SERVICE DIVISION
10654 MAGNOLIA BLVD., North Hollywood, California . . . TEL: 213-769-2720

Circle 7 on literature card

Quick-connect Fuseholders and Fuseblocks

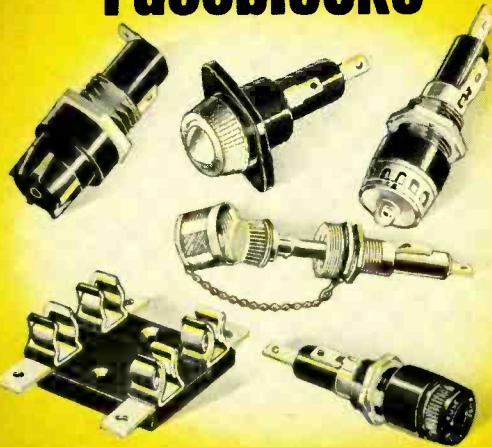

The complete line of BUSS fuseholders and fuseblocks is available with quick-connect terminals to save assembly time and cut costs.



Write for BUSS Form SFB

Bussmann Mfg. Division, McGraw-Edison Co., St. Louis, Mo. 63107

network tests scheduled for completion early in July.

The EIA broadcast committee also is considering the broader question of whether any changes in television broadcast signal specifications are appropriate in order to assure better color uniformity. Such considerations involve items beyond the VIR signal, and some of the additional considerations include: The advisability of tightening up tolerances on sync and burst timing specifications; and the possible need to update specifications regarding gamma, primaries, and reference white.

RCA Service Adds Another Center

RCA Service Company plans in July to open a service center in the Oakland Ridge Industrial Center of Columbia, Maryland.

The new facility, like other RCA Service Company facilities, will provide service for all home entertainment electronic products.

Columbia is located midway between Baltimore and Washington, D. C.

FM Radio Penetration Increases in 1969

The FM share of the radio market continued to grow in 1969, according to statistics compiled by the Electronic Industries Association (EIA) Consumer Products Marketing Service.

FM penetration of Total U.S. Radio Sales, including Auto Radio, reached a record 46.1 percent in 1969,

BUSS: The Complete Line of Fuses and . . .

Expectations of the Broadcast Television Systems Committee of the Electronic Industries Association (EIA) are realized.

The Committee, chaired by Bernard D. Loughlin, vice president for research, Hazeltine Corporation, is planning preliminary field tests of VIR signals in the near future. Upon completion of the tests, an EIA engineering report will be issued and made available to all interested persons.

VIR signals would provide broadcast stations with a constant color reference to confirm, before the signal is broadcast, that the chrominance-to-luminance ratio is correct and that the color burst represents a proper reference for both the phase (tint) and amplitude (saturation) of the chrominance signal.

Several variants of the VIR signal will be tried during these preliminary tests. The signal contains chrominance, luminance, and black-level references, and is proposed for Line 20 during the vertical interval just before the start of picture information. Tests will start with the signal on both fields, although some tests with the signal on one field only also are planned.

Engineering Departments of the broadcasting networks have actively participated in efforts of the EIA broadcast committee to develop the signal format and the plans for field tests, according to Mr. Loughlin. Present planning calls for local on-air tests in the New York City area to be run before early June, with

Tron Rectifier Fuses



Available in sizes from 1/2 to 1000 amps for voltages up to 1500, TRON Rectifier Fuses are ideal for protecting variable speed drives, inverters, battery chargers, plating power supplies, power controls, and any other application where fast opening and great current limitation are required.



Write for BUSS Form TRFS

Bussmann Mfg. Division, McGraw-Edison Co., St. Louis, Mo. 63107

Circle 8 on literature card

FUSES

for protection of Electronic Devices



There is a complete line of BUSS Quality fuses in 1/4 x 1 inch, 1/4 x 1 1/4 inch, and miniature sizes, with standard and pigtail types available in quick-acting or dual-element slow blowing varieties.



Write for BUSS Form SFB

Bussmann Mfg. Division, McGraw-Edison Co., St. Louis, Mo. 63107

nected to an estimated 3,728,880 homes, or 6.4 percent of all U.S. TV households, according to A. C. Nielsen, a research and inquiry service company.

Nielsen estimates that the rate of growth of CATV from spring to fall, 1969, was 6.7 percent, and erratic.

West Coast Retail Chain Sells 6-Year Warranty on B-W and Color CRT's

A six-year warranty on black-and-white and color picture tubes is being offered for \$7 and \$12, respectively, by Handy Andy, a West Coast retail home entertainment and appliance chain, according to a report in **Home Furnishings Daily**.

The warranty reportedly is prorated after the manufacturers' standard warranties and does not cover labor for replacement of the CRT.

Sylvania Appoints Northwest Distributor

Sylvania Electronic Components, an operating group of Sylvania Electric Products Inc., has appointed Cramer Electronics of Redwood City, Calif., as a franchised distributor in the Pacific Northwest.

Cramer Electronics will distribute Sylvania receiving tubes, TV picture tubes, semiconductor devices, and special electronic products in northern California, Oregon and parts of surrounding states. ▲

Fuseholders of Unquestioned High Quality

up from 39.7 percent in 1968 and 33.6 percent in 1967.

The FM share of total home radio sales in 1969 passed the 50 percent mark for the first time, reaching 55.3 percent of the record 41,476,000 sets sold. This represents a steady growth from 49.6 percent in 1968 and 40.3 percent in 1967.

Auto FM radio sales also showed a steady penetration growth from 9.9 percent in 1967 to 10.9 percent in 1968 to 14.0 percent in 1969.

		1969	1968	1967
	Total Sales	FM	%	%
Table	4,681	2,280	48.3	51.9
Clock	7,801	4,121	52.8	33.0
Portable	26,932	14,504	53.8	48.3
Total	39,414	20,905	53.0	46.4
TV/Phono/Comb.	214	214	100.0	100.0
Radio/Phono/Comb.	1,848	1,848	100.0	100.0
Home Total	41,476	22,967	55.3	49.6
Automobile	11,939	1,677	14.0	10.9
Total	53,415	24,644	46.1	39.7

CATV Feeds 6.4% of U.S. TV Households

Cable TV (CATV), as of Nov., 1969, was con-

Subminiature Fuses and Fuseholders



BUSS has the fuses and fuseholders for space-tight applications, in a wide range of ampere ratings from 1/100 to 15. Allow visual inspection of element. Tiny but tough, they're built to withstand severe environments.



Write for BUSS Form SFB

Bussmann Mfg. Division, McGraw-Edison Co., St. Louis, Mo. 63107

Circle 9 on literature card

Opposed To Technician Licensing

I have been hearing lately a lot about the licensing of television service men. I think it is one of the most worthless ideas that has ever come along.

Licensing will not solve any existing problems. It has not stopped doctors or lawyers who want to cheat the public from doing just that, and it will not stop service men who want to do the same thing. Licensing will, however, add an extra burden on the already overburdened television repairman.

I think it is ridiculous to think any television technician could start a profitable business without at least three years of schooling. Once a television repairman has graduated from his particular school, he is not concerned with theory, which technician licensing would require. He is more interested in and concerned with troubleshooting and time-saving techniques for repairing consumer electronic products. I think if a service man could pass strict licensing tests, which are based on a great deal of theory, he would be engineer material and should look for an engineering position. It is not necessary to have a deep knowledge of theory to fix a television.

Since the service business already is hurting from a shortage of technicians, preparing for licensing tests will only take more of the technician's valuable time—time he needs to study troubleshooting literature.

Color and solid-state devices will, in time, take care of your so called part-timers and fly-by-night organizations. This will accomplish what licensing is supposed to do, leaving only top-grade technicians.

I think the problem is this: People are being cheated, and someone wants to stop it. However, cheating does not pertain only to the television business. It pertains to every business in the United States today. I feel the proper thing to do is to educate the public. If the people would think twice before taking their televisions, etc., to the fly-by-night organizations, they would not have to worry about being cheated. Let's put out pamphlets and advertise established service company names. Let's also print brochures for the public containing information on what to expect from their service man. By doing this, the public would be well informed. If they then took their sets to a part-timer, they would know what to expect and have no one to blame but themselves.

Joseph F. Sgarlat, Jr.
Forty Fort, Pa.

Business Opportunity

I have an excellent business here in South Georgia. The people are friendly and the climate is very pleasant, but the time has come for me to step down, because of age.

It would be an excellent venture for one or two

younger men to take over. It is fully equipped and has been well established over the past 21 years in this same location. It includes: large shop, modern 3-bedroom home, all on approximately 1 acre of land with large front to a US highway.

We have enjoyed your publication for many years; in fact, we plan to stay on the mailing list for some time to come, so that we can keep up with the new things as they come out.

William H. Reynolds, Sr.
Emerson Park TV & Electrical
Appliance Service Co.
R.F.D. 3, Box 217
Waycross, Ga. 31501

Back Copies

I have copies of PF Reporter in A-1 condition from January 1960 to February 1970 available to anyone who would be interested in them at a very fair price.

Harry A. Yenney
1819½ Fremont Ave.
S. Pasadena, Calif, 91030

Manufacturer's Numbers On PHOTOFACt's

Why are the component numbers on PHOTOFACt schematics different from those assigned by the manufacturer?

J. R. Racine
South Burlington, Vt.

(Mr. Racine, I have forwarded your question to the manager of the PHOTOFACt division of Howard W. Sams & Co., Inc., Joe Groves. Following is his reply:)

We have been using manufacturers' item numbers in PHOTOFACt, starting with our coverage of the Philco-Ford TV in Set 1032.

Unfortunately, the reason we were unable to do this earlier stemmed from the wide variety of component identification numbers used by manufacturers, and limited art techniques which would permit high-volume output as required by PHOTOFACt to satisfactorily reproduce the wide range of numbers. However, as technology advanced we were able to implement this into our PHOTOFACt format.

Probable Causes of Excessive Brightness in Zenith Chassis

I have a suggestion concerning Ed Anderson's question about excessive brightness in a Zenith 23XC38 chassis, which appeared in the Troubleshooter department of the March 1970 issue of ELECTRONIC SERVICING.

It has been my experience that the above problem is probably caused either by a defective L21, Zenith part No. 20-2710 luminance boost coil, or by a defective X12, Zenith part No. 212-77 silicon diode.

"My shop's been loaded since I got my FCC License... and I could kick myself for not getting it sooner. I'm pulling in all kinds of mobile, marine and CB business that I couldn't touch before; have even had some calls to work on closed-circuit television. I've hired two new men to help out and even with them, I'm two weeks behind."

And so it goes. Once you have that FCC ticket, you open the door to all kinds of new business. And that's not all. The knowledge you need to pass the FCC exam gives you a fundamental understanding of *all* electronics. You'll find you can do more work in less time...work on almost *any* kind of electronics gear.

What's the best way to get a Commercial FCC License...and still keep up with your work? Thousands of men will tell you, "Cleveland Institute of Electronics."

Men like August E. Gibbemeyer, for example. He was in radio-TV repair work before studying with CIE and getting his 1st Class FCC License. Now, he writes, "We are very happily in the marine and two-way radio business... servicing police and fire departments in three communities, as well as cab

companies...and our trade has grown by leaps and bounds."

Ed Dulaney is another example. He started his own part-time service business after training with CIE and passing the FCC License exam. This worked out so well that he then opened a full-time business. Today, he reports, "I manufacture my own two-way radio equipment, with dealers who sell it in seven states, and have seven full-time employees."

CIE has been preparing men like these for FCC License exams since 1934. What's more, CIE backs its Home-Study Licensing Programs with this remarkable money-back offer:

A CIE home-study FCC License course will quickly prepare you for a Commercial FCC License. If you fail to pass the FCC examination after completing your course, CIE will refund all your tuition. You get an FCC License...or your money back!

And only CIE offers you new, up-to-the-minute lessons in all these subjects: Advanced Troubleshooting Techniques, How To Work With Transistors, Microminiaturization, Pulse Theory and Application, and many more.

Send bound-in postpaid card today for CIE's FREE informative book "HOW TO GET A COMMERCIAL FCC LICENSE." With it, we'll include a second FREE book, "HOW TO SUCCEED IN ELECTRONICS." If card is missing, use the coupon below. Cleveland Institute of Electronics, 1776 East 17th Street, Cleveland, Ohio 44114.

NEWS FOR VETERANS: New G.I. Bill may entitle you to Government-paid tuition for CIE courses if you had active duty in the Armed Forces after Jan. 31, 1955. Check box in coupon for complete information.

CIE
Cleveland Institute of Electronics
1776 East 17th Street, Cleveland, Ohio 44114

Please send FREE book, "How To Get A Commercial FCC License." Also include your second FREE book, "How To Succeed In Electronics."

Name _____ Age _____
(Please Print)

Address _____

City _____

State _____ Zip _____

Veterans check here for GI Bill information

 Accredited Member National Home Study Council
A Leader in Electronic Training... Since 1934

PF-63



"My shop's
been loaded...
since
I got my
FCC
License."

Circle 10 on literature card

Usually I have found coil L21 open.

I hope this of some benefit to your readers.

Louis E. Peck
Pleasure Ridge Park, Ky.

Help Needed

I need information on a Grundig record player Model Mandello-b 5263 HE. I need a cross reference on the EAF-801 tube and on the cartridge or needle, which has the number AG 3306 AHDT or AG 3310 AHDT. This model is not listed in Sam's PHOTOFACT's, and a letter to Grundig in New York came up with the information that they did not import that model.

Any help would be greatly appreciated.

Donald C. Treece
Don's Electronic Service
Route #3
Kahoka, Mo. 63445

I have the instruction manual for a Mohawk Midge-tape tape recorder Model BR-1 manufactured by the Mohawk Business Machines Corp., but the manual mentions no battery numbers or values. I have exhausted all sources of information, including the company itself, PHOTOFACT, Supreme and myself. I would appreciate any information on this tape recorder, and I also would like to obtain some spare cartridges.

Frank O. Stratman
Box 264
Dresden, Ohio

I have been using a Hickok Model 820 Tube Caddy Pal, which is a combination VTVM and a tube and transistor checker, for some years. Through use, the chart has become frayed and, finally, useless. I have written the Hickok company, but they cannot supply me with another chart. Perhaps one of your readers will be able to help me.

Edward Lambert
1339 Princess Ave.
Camden, N.J. 08103

We have a Kaye-Halbert Model 6265 stereo AM/FM tuner and record player combination in the shop and need the schematic and service data on this set. If any readers have a schematic, we would be glad to buy it. Thank you for your help.

Fred J. Harold
2815 NE 53rd Ave.
Portland, Ore. 97213

I recently acquired a Jr. Beamer Model CB-77N CRT tester made by Raytronic Laboratories, Inc. of Cincinnati, Ohio. However, it is my understanding that they have gone out of business. I have been unable to obtain either a schematic or operating instructions for this tester.

I would greatly appreciate any information anyone could give me on this instrument, or how I could obtain this information.

Dale C. Houser
6808 Vienna Court
Springfield, Va. 22150

Your caddy is the only caddy our tubes fit.

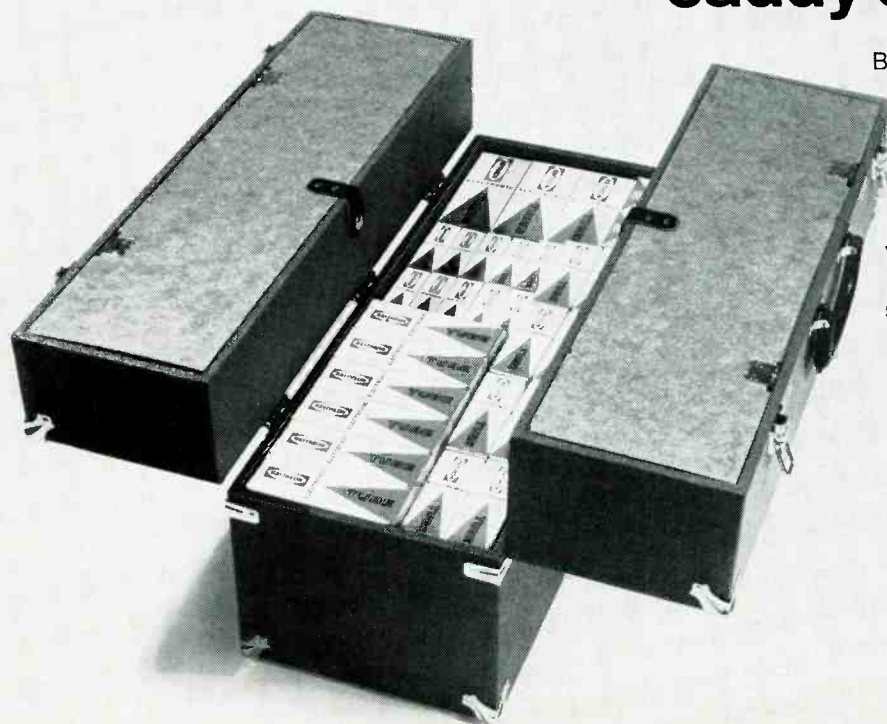

Because we market our tubes only through you—the independent serviceman.

We don't have service trucks or retail outlets. Our tube caddies are available only to you.

You see, we're independent too—the largest independent tube supplier in the business. We have to cooperate with you—not compete. Because we depend on you just as you depend on us.

RAYTHEON

Circle 11 on literature card

Now a Heathkit®

Solid State Vectorscope/Color Generator

Only \$124.95*

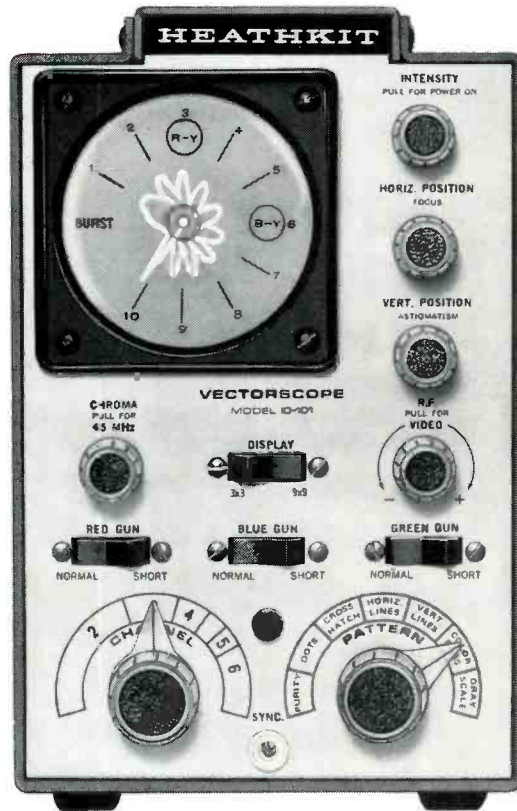

Accurately Performs All Of These Adjustments:

- Raster
- Static & Dynamic Convergence
- Purity
- Gray Scale

- 3.58 MHz Oscillator
 - Reactance Coil
 - Phase Detector Transformer
 - Demodulator Angle Check
 - Chroma Bandpass Touch-Up
- Kit IO-101, 12 lbs. \$124.95*

Fast switch selection of standard 9 x 9 display . . . or exclusive Heath "3 x 3" display

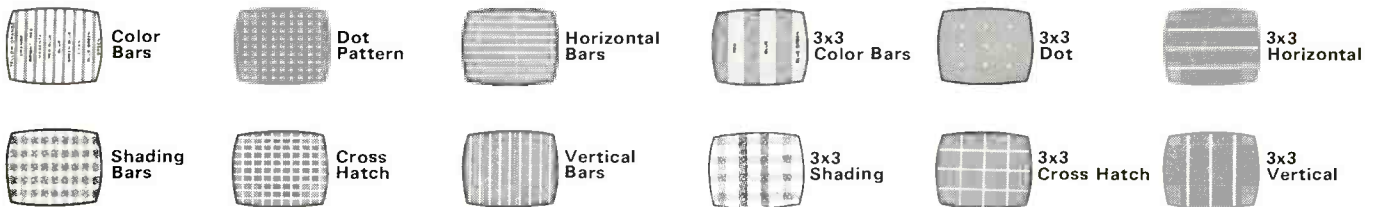

IO-101 SPECIFICATIONS — PATTERNS — Purity: Produces a snow-free raster for purity adjustments. **Dots:** 9 x 9 produces a display of 110 small dots. 3 x 3 produces a display of nine dots for convergence adjustments. **Crosshatch:** 9 x 9 produces a display of 11 vertical and 10 horizontal lines. 3 x 3 produces a display of three vertical and three horizontal lines for convergence and linearity adjustments. **Horizontal Lines:** 9 x 9 produces a display of 10 horizontal lines. 3 x 3 produces a display of three horizontal lines for vertical linearity and pin-cushion adjustments. **Vertical Lines:** 9 x 9 produces 11 vertical lines. 3 x 3 produces a display of 3 vertical lines for horizontal linearity and convergence adjustments. **Color Bars:** 9 x 9 produces a display of ten standard color bars. 3 x 3 produces a display of three standard color bars. A visual fingerprint (voltage pattern) of all ten color bars in the form of a petal pattern is displayed for color circuit servicing. **Gray Scale:** Provides a wide bar crosshatch pattern with six shades of brightness for color gun level adjustments. **OUTPUT SIGNALS — Video:** Greater than ≈ 1 volt peak-to-peak composite signal for composite signal injection beyond the video detector. **RF:** Variable to approximately 25,000 uV output, channels 2 through 6, for composite signal injection into the TV receiver antenna input terminals. **Sync:** Greater than 3.5 volts peak-to-peak signal for servicing sync circuits without video, or sets having separate video and sync demodulator phase adjustments. **GENERAL — Power Requirements:** 105-125 or 210-250 VAC, 50/60 Hz, 20 Watts. **Cabinet Dimensions:** 6 $\frac{3}{4}$ " W x 9 $\frac{1}{4}$ " H x 14 $\frac{1}{2}$ " D. **Net Weight:** 9 $\frac{1}{2}$ lbs.

*The number of dots, lines, and bars indicated for a 9 x 9 display is the number displayed if the receiver under test has no overscan.

HEATH COMPANY, Dept. 25-6
Benton Harbor, Michigan 49022



- Please send FREE Heathkit Catalog
- Please send IO-101 Specification Sheet
- Enclosed is \$_____ plus shipping.
Please send Model IO-101

Name _____
Address _____
City _____ State _____ Zip _____

Prices and specifications subject to change without notice.
*Mail Order Prices; F.O.B. Factory

TE-222

Circle 12 on literature card

Consumer electronic servicing—a look at where it's heading

Comparisons of statistics from a variety of reliable sources reveals past trends that, for the most part, are continuing today. by J. W. Phipps

- Number of electronic service establishments decreased
- Total annual receipts increased
- Shops with employees received bigger chunk of business
- Increases of prices charged for TV servicing lagged behind the increase in cost of doing business
- Margin of profit decreased
- Number of technicians employed increased

These and other trends of the consumer electronic servicing business over the four year period 1963-1967 have been detected by comparing statistics from a number of sources, including the 1963 and 1967 Census of Business, compiled and published every four years by the U. S. Department of Commerce. Because of the complexity of gathering and cross checking information from a number of sources, the Census of Business usually is not ready for release until two or three years after the report year. The 1967 Census of Business was released in March of this year.

Although most of the following statistics and trends relate directly to the four year period 1963-1967, this writer, with only one exception, has uncovered no factual information that indicates these trends have reversed. In fact, some of the trends seem to have accelerated. The one exception is the typical hourly pay of technicians, which our studies indicate has improved significantly, but still falls short of the hourly pay of most other skilled trades.

The following statistics are compiled from the 1963 and 1967 Censuses of Business, unless otherwise indicated.

Statistics 1963-1967

- **NUMBER OF SERVICE ESTABLISHMENTS DECLINED**—The total number of shops servicing home entertainment and communications electronic products decreased 23 percent.

1963	43,208
1967	33,063
Decrease	10,145 (-23%)

- **NUMBER OF ONE-MAN SHOPS DECREASED MORE THAN NUMBER OF SHOPS WITH EMPLOYEES**—The total number of one-man shops decreased 29 percent, compared to only 2 percent decrease of shops with employees. In 1963, one-man shops represented 80 percent of the total service establishments. By 1967, this percentage had decreased to 75 percent.

	SHOPS WITH EMPLOYEES	ONE-MAN SHOPS
1963	8,713	34,495
1967	8,549	24,514
Decrease	164 (-2%)	9,981 (-29%)

- **ANNUAL TOTAL RECEIPTS INCREASE**—The annual total receipts, or gross income, of the servicing industry increased 11.8 percent.

1963	\$628,485,000
1967	\$702,912,000
Increase	\$ 74,427,000 (11.8%)

- **NUMBER OF SETS IN USE INCREASED**—According to statistics compiled and published by the Consumer Products Division of the Electronic Industries Association (EIA), the total number of home and auto radios, monochrome and color TV's and phonographs in use increased 34%.

1963	\$496,600,000
1967	\$667,100,000
Increase	\$170,500,000 (34%)

● **TOTAL ANNUAL GROSS INCOME OF SHOPS WITH EMPLOYEES INCREASED, WHILE THAT OF ONE-MAN SHOPS DECREASED**—The total annual receipts taken in by shops with employees increased 35%; total receipts for one-man shops declined 21%.

	RECEIPTS SHOPS WITH EMPLOYEES	RECEIPTS ONE-MAN SHOPS
1963	\$380,939,000	\$257,546,000
1967	\$500,390,000	\$202,522,000
Increase	\$129,451,000 (35%)	Decrease \$ 55,024,000 (-21%)

● **AVERAGE ANNUAL GROSS INCOME OF SHOPS WITH EMPLOYEES INCREASED MORE THAN THAT OF ONE-MAN SHOPS**—The average annual receipts taken in by each shop with employees increased 14 percent, 3 percent more than the increase realized by one-man shops.

	AVG. RECEIPTS SHOPS WITH EMPLOYEES	AVG. RECEIPTS ONE-MAN SHOPS
1963	\$42,573	\$7,466
1967	\$58,531	\$8,261
Increase	\$ 5,958 (14%)	\$ 795 (11%)

● **NUMBER OF EMPLOYEES OF SERVICE SHOPS INCREASED**—The total number of personnel employed by service shops increased 18 percent, increasing the average per shop 17%.

	SHOPS WITH EMPLOYEES	TOTAL EMPLOYEES	AVERAGE PER SHOP
1963	8,713	25,012	2.9
1967	8,549	29,415	3.4
	164 (-2%)	4,403 (+18%)	.5 (+17%)

● **AVERAGE ANNUAL SALARY OF SERVICE SHOP EMPLOYEES INCREASED**—The average annual salary paid employees of service shops increased 34%.

1963	\$3,967
1967	\$5,326
Increase	\$1,359 (34%)

More of Total Business Is Being Done By Larger Shops

The preceding statistics indicate that receipts taken in by one-man shops in 1963 represented only 41%

% of 1957-1959 Average

Comparative Price Index 1953-1969

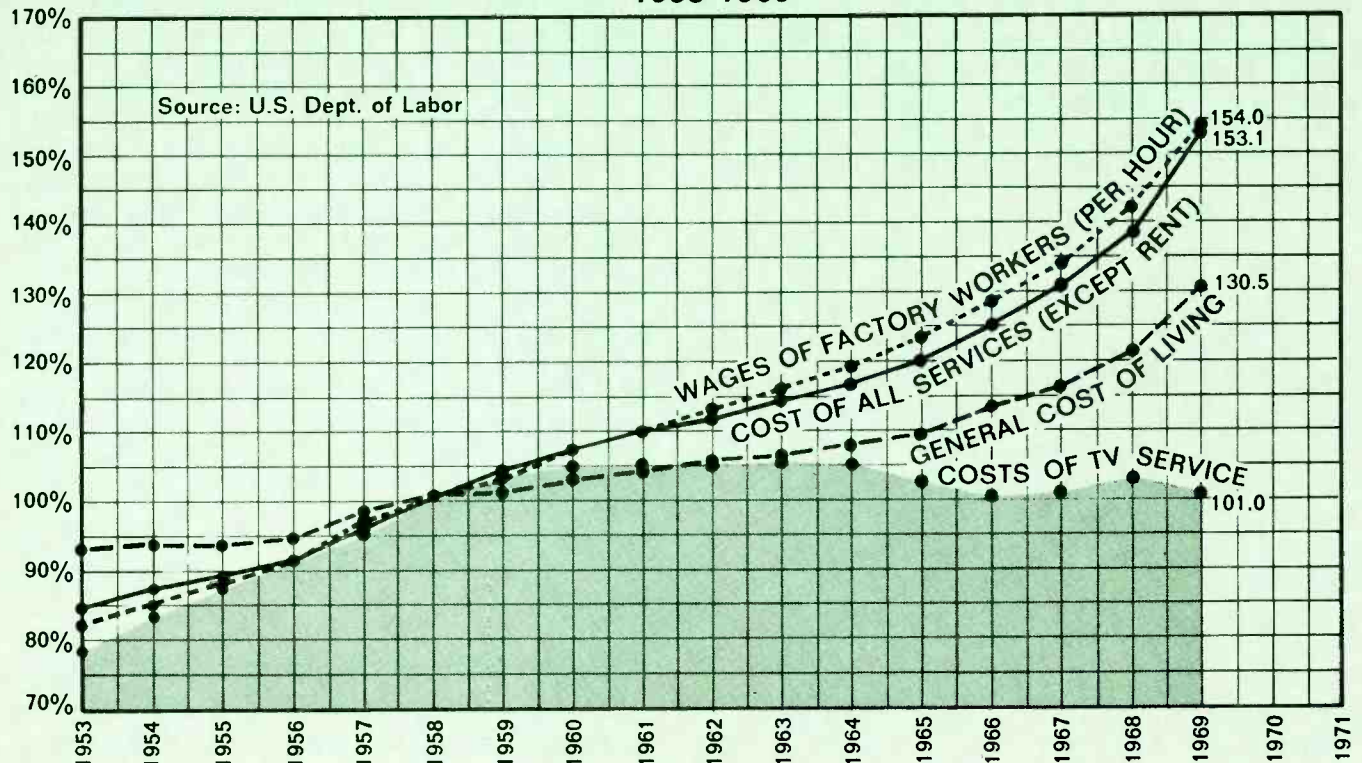

of the total dollar-volume of electronic servicing that year. By 1967, this percentage had dropped further, to 29%.

● IN 1963—20 PERCENT OF SHOPS (THOSE WITH EMPLOYEES) WERE DOING 59 PERCENT OF THE TOTAL ANNUAL BUSINESS

● IN 1967—25 PERCENT OF SHOPS (AGAIN, THOSE WITH EMPLOYEES) WERE DOING 71 PERCENT OF THE TOTAL ANNUAL BUSINESS.

1967		
Service receipts, shops with employees	\$500,390,000	71%
Service receipts, shops with employees	202,522,000	29%
	<u>\$702,912,000</u>	<u>100%</u>

Large Gap Exists Between The Increase of Sets in Use And The Increase In The Dollar Volume of Business

One measure of the potential of the consumer electronic servicing business is the number of sets in use. Between 1963 and 1967, the total number of monochrome and color TV sets, home and auto radio and phonographs increased from 496.6 million to 667.1 million, or 34 percent. During the same period, the total annual dollar-volume of the consumer electronic servicing business increased by only 11.8%. The difference between the increase of sets in use and the increase in dollar-volume of the electronic service business is 22.2 percent.

A portion of this difference can be attributed to reduced incidence of the need for servicing, brought about by the switch from tube to solid-state design of b-w TV and audio equipment, which occurred immediately before and during the four-year period being analyzed.

Another portion of this difference probably can be related to the fact that between 1964 and 1967 the consumer cost of TV servicing actually decreased about 5 percent.

However, it is doubtful that either of these two factors—the switch to solid-state design and reduced consumer cost of TV servicing—account for more than half of the difference, leaving the remaining 10 percent as an actual increase in potential business that was not converted to service dollars by independent servicers.

Cost of Doing Business Spirals Up While Consumer Cost of TV Servicing Actually Decreases

Two indicators of the general trend of the cost involved in operating a relatively small, personal-service business are the Consumer Price Index and the Wholesale Price Index. An economist of the U. S. Department of Labor advised ELECTRONIC SERVICING that of these two, the Consumer Price Index, which covers both goods and services, more closely reflects the trend of business costs in the consumer electronic servicing business than does the Wholesale Price Index.

During the period 1963-1967, the Consumer Price Index increased from 106.7 to 116.3, or 9 percent, while the prices charged consumers for TV service decreased about 5 percent.

Thus, while the cost of producing TV service increased 9 percent, shop owners on the average were charging consumers 5 percent less than they were prior to this period, producing an effective 14-percent decrease in the margin of profit.

During the same period, the costs of all other services (except rent) increased 16 percent. As shown by the accompanying Comparative Price Index chart, in 1967 the consumer cost of TV service lagged behind the cost of other services by 30 percent.

From 1967 to 1969, the trend not only continued, but the gap between the cost of producing TV service and the prices charged consumers widened even more. By 1969, the cost of doing business (Consumer Price Index, or general cost of living) had increased 29.5% above the consumer cost of TV service, which effectively reduced the profit margin of TV shops even more.

From all indications, the net profit of TV service shops has continued to decline at an increasing rate since 1963.

Hourly Pay of Consumer Electronic Technicians Increases But Still Lags Behind That of Other Skilled Trades

Comparison of the average annual salary of electronic service shop employees for the years 1963 and

HOURLY PAY OF UNION BUILDING TRADES—JULY, 1969

Trade	Average	Range
Bricklayers	\$6.14	\$4.40-\$7.16
Carpenters	5.84	3.80- 7.20
Electricians	6.10	4.30- 7.35
Painters	5.40	3.25- 6.41
Plasterers	5.75	4.00- 7.00
Plumbers	6.29	4.60- 8.57
Building laborers	4.26	2.07- 5.62
All trades	5.59

1967 indicate that it has increased 34%. Because these statistics cover **all** employees, including clerical and other nontechnical help, the exact percentage of increase of technician's annual salaries is difficult to determine. However, unless large numbers of nontechnical people were eliminated from shop payrolls during the four-year period—and this is unlikely—technician employees **did** realize a substantial increase in average annual salary.

But, in comparison to the pay received by other groups of skilled employees, electronic technicians still are earning less than the average hourly pay and fringe benefits of comparably skilled craftsmen. For example, according to a recent report by the Labor Department's Bureau of Labor Statistics, the hourly wage scales of union building trade workers averaged \$5.59 as of July 1, 1969 (see accompanying table for pay rates of specific trades). This rate produced an average annual salary of \$11,600, based on a 40-hour work week. Results of a survey conducted by ELECTRONIC SERVICING in January, 1969, indicated that 60 percent of the technicians responding made less than \$4.00 per hour, or less than \$8,320 annually, also based on a 40-hour work week.

Thus, as of the first half of 1969, 60 percent of electronic service technicians were receiving 28% less pay than the **average** received by union building trade workers.

The Present and Future

Consumer electronic servicing seems to be slowly evolving into a "big-business" business. The number of one-man shops is declining at a substantially greater rate than are larger shops, and the remaining one-man shops are receiving a smaller portion of the total annual gross income of electronic servicing businesses.

Failure to adjust service charges upward to correspond to the increased cost of doing business has further reduced profit margins to a dangerously slim level that does not permit:

- a reasonable return on capital (including skill and knowledge) investment
- adequate compensation of technicians
- sufficient buildup of reserve for necessary purchases of new types of equipment and replacement of old
- improvement of efficiency through technician training programs
- owner or manager participation in management courses, conventions, and seminars

Although the pay and fringe benefits of consumer electronic technicians have improved, they still have not caught up with that of most other skilled trades. Until they do, a career in servicing consumer electronic products will not be as attractive to prospective trainees as one in the other skilled trades, and the alleged shortage of trainee and skilled electronic technicians will continue. ▲

Service Training Schedule

Consumer electronic service training sessions conducted by TV manufacturers, distributors, service associations and universities, which are open to all interested consumer electronic service technicians, are announced in this column. Send the dates, location and a brief description of the subjects to be covered to: Service Training, ELECTRONIC SERVICING, 1014 Wyandotte St., Kansas City, Mo. 64105. All information should be submitted at least two months prior to the date of the training session.

NORTHERN ILLINOIS UNIVERSITY*, Dekalb, Ill. 60115:

- **ELECTRONIC TECHNOLOGY WORKSHOP**, June 15-August 7, 1970. 8:00 to 10:00 daily. Erwin Hamm, instructor. (3 semester hours)

The objectives of this workshop are to update and enhance electronic technology competency. The emphasis will be on the mathematical-physical science concepts as applied to electrical technology. The content primarily is for recent graduates of a two-year occupational electronics technology program or industrial education teachers needing a refresher in electronics technology. A well-equipped, modern electronics technology laboratory is available for verification of analytical results in addition to IBM 360/50 computer facilities.

- **SEMICONDUCTOR AND IC WORKSHOP**, August 10-14, 1970. 8:00 to 4:00 daily. Goodwin Petersen and Charles McKay, instructors. (1 semester hour)

Beginning with semiconductor devices, this workshop leads systematically into integrated circuits and applications. Each participant works four to five hours each day at a fully equipped electronics station. Staff members are available at all times to answer individual questions. A lecture-discussion period precedes and follows each laboratory session.

*Undergraduates must obtain application forms and permit to register from the Office of Admissions, Northern Illinois University. Please write to the Director of Admissions immediately. ▲

New Service Literature

TV TECH AID, Edward G. Gorman, Kings Park, L.I., New York 11754; printed monthly; yearly subscription \$7.95.

A monthly summary of actual color and b-w TV trouble symptoms, their possible causes and the cure for each. Where needed, a schematic of the circuitry involved is included.

The troubles and cures are grouped according to manufacturers which, in turn, are listed alphabetically. The format of the publication is designed to facilitate filing the troubles and cures according to manufacturer and chassis number—a definite aid to quicker servicing.

Step-by-step operation of a triggered-sweep scope

A review of fundamental operating techniques.
by Robert G. Middleton.

A triggered-sweep scope has many advanced features in comparison to an ordinary service-type scope. However, the most definitive characteristic of a triggered-sweep scope is a start-stop, time-base generator (the Schmitt-trigger block in Fig. 1). Horizontal deflection does not start until the leading edge of a pulse (or other waveform) arrives through the trigger-input amplifier.

Some of the controls on triggered scopes are familiar to technicians who have been using conventional service-type scopes. These familiar controls are:

- Intensity control and "on-off" switch.
- Focus (and associated astigmatism) controls.

- Vertical-input attenuators.
- Vertical and horizontal centering controls.
- Vertical calibrator control.

One less familiar control on a triggered-sweep scope, the time/cm control (Fig. 2), has the same basic function as the horizontal-deflection frequency control on a service-type scope, except that the stepped section of the time/cm control is accurately calibrated, so that each centimeter of horizontal deflection represents a known elapsed time. In most applications, the continuous time/cm (vernier) section of the control is not used, and is left snapped into its reference (CAL) position. (NOTE: The continuous time/cm function is not calibrated,

so elapsed-time intervals cannot be measured accurately when this function is in use.) The other time base controls have no parallel in conventional scopes. Their operation and functions will be explained in the following step-by-step procedures.

Display of Sine Waves

To display a sine wave on the CRT screen, connect the output from an audio oscillator (or even a heater line) to the vertical-input terminals of the triggered-sweep scope. Turn the scope on, and allow the unit to warm up. Make preliminary control adjustments as follows: intensity—minimum; focus—centered; astigmatism—centered; vertical attenuator— $\frac{1}{3}$ of maximum; trigger selector—AUTO, and + INT. (see Fig. 3); triggering-level control—minimum to left (see Fig. 4); stability control—centered (see Fig. 4); horizontal-display control—NORM. (control is seen in Fig. 4); time/cm control—centered (see Fig. 2); vertical-positioning control—centered (seen in Fig. 2); and horizontal-positioning control—centered (seen in Fig. 2).

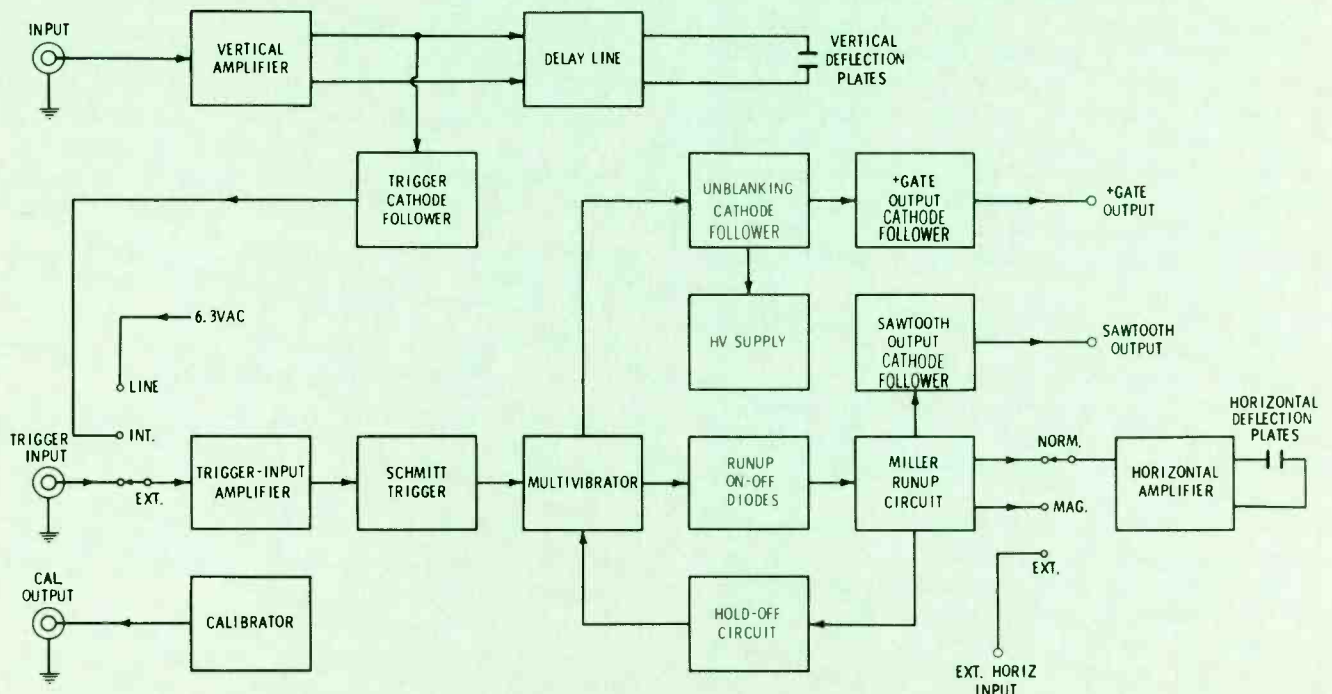

Fig. 1 Block diagram of a triggered-sweep scope.

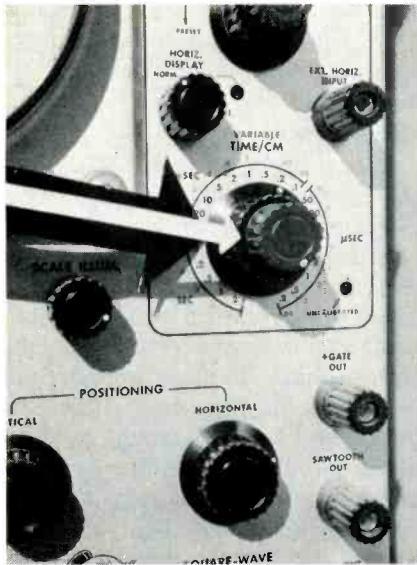

Fig. 2 Black arrow points to step time/cm control; white arrow points to continuous time/cm control.

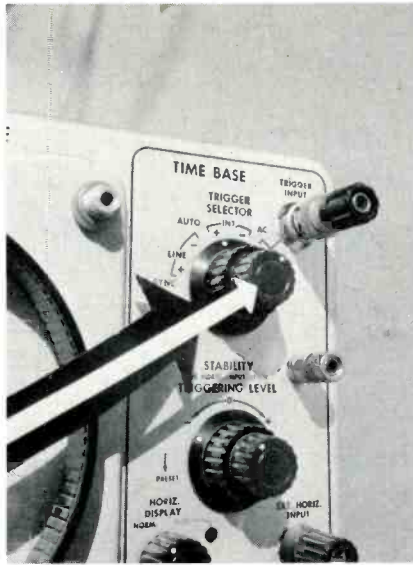

Fig. 3 Black arrow points to EXT.-INT.-Line selector; white arrow points to mode selector.

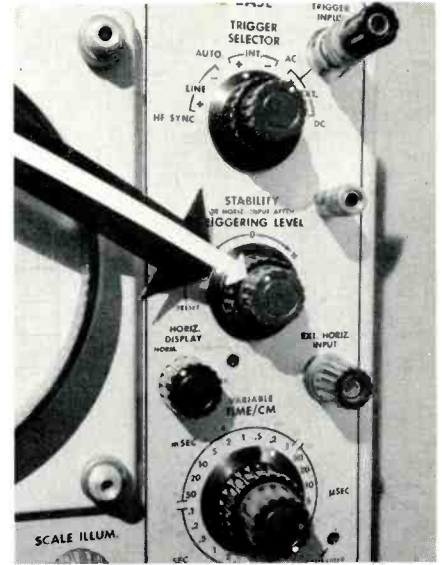

Fig. 4 Black arrow points to triggering-level control; white arrow points to stability control.

Use the AUTO. (automatic) mode of time-base operation to start with, because it is the simplest type of operation, and because the time base is free-running. None of the time-base controls needs to be adjusted in this mode, and sync lock is automatic. In other words, the trigger-level and stability controls (Fig. 4) are inoperative in the AUTO. mode.

As in the case of a service-type scope, adjust the horizontal-deflection rate (time/cm control, Fig. 2), to display the desired number of cycles on the screen. The visibility of a horizontal trace in the absence of a vertical-input signal and the automatic synchronization provided in this mode are very useful features. The chief disadvantage of the AUTO. mode is that the starting point of the waveform in the displayed pattern cannot be controlled, nor can a section in a waveform (such as a color burst) be isolated for individual display.

AC Triggering Mode

With the same sine-wave vertical input as before, turn the trigger-selector control (Fig. 3) to its AC position. Then, advance the stability control to the right until a stable pattern is displayed. (In the case of

a sine-wave pattern, there is a considerable range over which a stable display is obtained.) While turning the control, the pattern stops running horizontally and locks in sync. But if the stability control is turned too far, the screen suddenly becomes blank.

Next, as the triggering-level control (Fig. 4) is turned back and forth, observe that the starting point on the waveform moves up or down in the pattern. This action is depicted for a trapezoidal waveform in Fig. 5A. It is essential when displaying a waveform for measurement of rise time (Fig. 6).

When the trigger-selector switch (Fig. 3) is set to its -INT. position, the displayed waveform is shifted 180° in phase; as the triggering-level control (Fig. 4) is turned back and forth, the starting point on the waveform moves up or down in the pattern, as shown in Fig. 5B.

These level and polarity functions are used to trigger the sweep at a desired point in a complex waveform, in order to pick out a specified interval for individual display.

Of course, these basic functions might not be sufficient when measuring highly complex waveforms, such as color-bar patterns, in which case one of the following functions must be employed.

DC Triggering Mode

When the trigger-selector control is set to the DC position, waveform locking action is much the same as in the AC triggering mode. However, there are some important differences in details. For example, the low-frequency response is better in the DC mode: If the scope will not lock on a low-frequency waveform, switch the triggering mode from AC to DC. Also, the triggering point now changes on the waveform as the display is moved up or down on the screen with the vertical-positioning control. Therefore, when using the DC triggering mode, it might be necessary to readjust the triggering-level control after the vertical-positioning control is changed.

Since neither the AC nor the DC triggering modes are very effective at frequencies above 5 MHz, a high-frequency (HF) position also is provided by the trigger-selector switch.

HF Sync Mode

The use of the HF sync function is observed to best advantage by feeding to the vertical-input terminals a CW signal of approximately 10 MHz from a signal generator. This is a somewhat simpler function than the AC or DC modes, because only the stability control now affects the locking of the pattern. In other

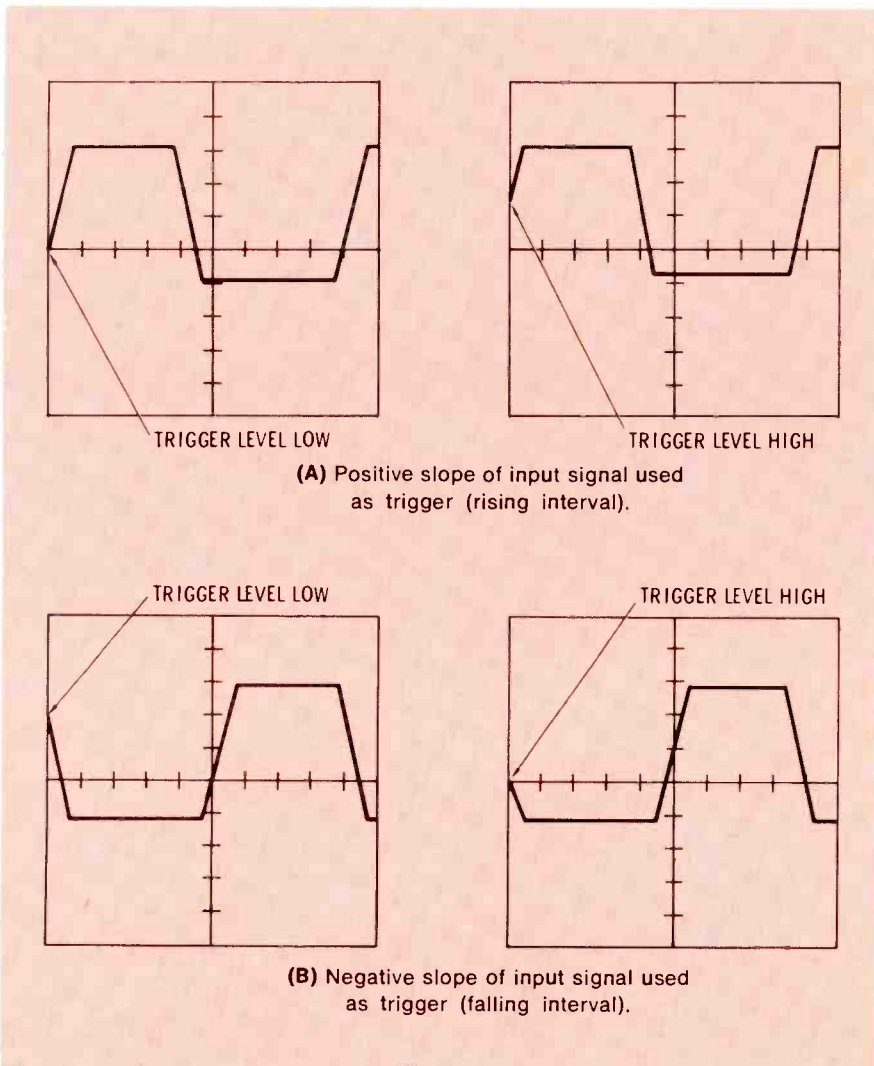

Fig. 5 Triggered scope waveforms.

words, the triggering-level control is inoperative when the HF sync mode is in use.

This mode is very useful when troubleshooting a short-wave receiver or transmitter. With it, an oscillator or amplifier waveform can be analyzed for significant harmonics or other types of distortion.

Magnifier Operation

The horizontal-display control is seen in Fig. 3. When set to its MAG. (magnifier) position, the horizontal-amplifier gain is increased five times. Since the trace now occupies a much greater length, the intensity control must be advanced to obtain normal pattern brightness. (NOTE: Before the horizontal-display control is switched back to its NORM. (normal) position, the in-

tensity control should be turned down to avoid the possibility of burning the fluorescent screen.)

The magnifier function is used when checking the leading or trailing edges of fast-rise or fast-fall waveforms, as illustrated in Fig. 6.

Trigger-Signal Sources

External position

In various applications, use of the EXT. (external) setting of the trigger-selector switch is advantageous, or even essential. For example, it is used when separating the color burst from a color-bar waveform. Thus, if a sample of the burst signal from the burst amplifier in a color receiver is fed to the trigger-input terminal of the scope (Fig. 3), it is easy to lock in the color burst, even if the test probe is moved from one

point to another in the chroma circuits. The appearance of an expanded color-burst waveform is illustrated in Fig. 7.

Line position

When testing in power-frequency (60-Hz) circuits, the LINE position of the trigger-selector switch can be very helpful. Consider the problem of phase identification: In a three-phase power-supply system, the combination waveform (Fig. 8) shows phase 1 going through its peak near the beginning of the pattern, phase 2 going through its peak about one-third down the horizontal axis, and phase 3 going through its peak about half-way down the axis. If we use the line sync function, these relative peak positions will be maintained on the screen, regardless of whether we feed one phase, two phases, or all three phases into the vertical-input terminals.

Peak-to-Peak Voltage Measurements

Measurement of p-p voltages is a simple procedure with a triggered-sweep scope, because each step of the vertical attenuator is calibrated in terms of p-p voltage per centimeter (p-p/cm) of vertical deflection. Although this vertical calibration is accurate and stable, it is customary also to provide a 1-volt p-p regulated square-wave voltage for calibration checks. Most technicians prefer to verify the vertical calibration at weekly intervals.

The square-wave calibrating voltage has a repetition rate of 1 KHz in a typical scope. It is not intended for square-wave testing of audio amplifiers, or other circuits, because it has comparatively slow rise and fall. When square-wave tests are necessary, it is essential to use a good-quality generator with fast rise. For example, the scope used in the illustrations in this article has a rise time of less than 20 ns (0.02 μ s). A square-wave generator used with this scope for circuit tests also should have a rise time in the order of 20 ns.

Low-C Probe

To avoid waveform distortion caused by circuit loading, medium- and high-impedance circuits should be checked with the aid of a low-

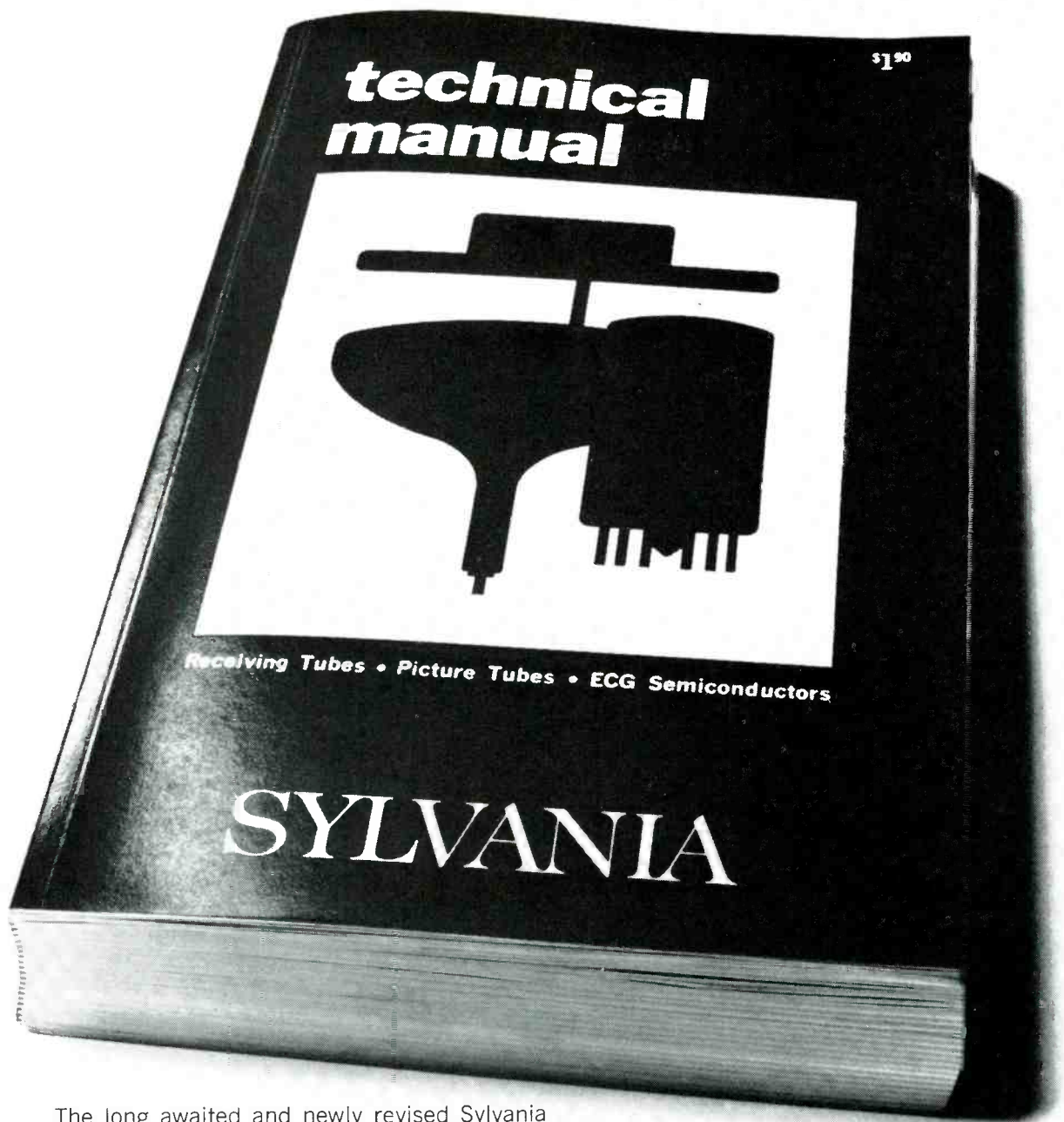

The long awaited and newly revised Sylvania Technical Manual is out. Complete and unexpurgated. The fantasy of every Independent Service Technician. Written anonymously by an agile team of Sylvania engineers. 32,000 components described in breathtaking detail. Including thousands of unretouched diagrams and illustrations. Discover the unspeakable thrill of new color TV Tubes, listed as never before. The ecstasy of 28,000 ECG Semiconductors.

From exotic Deflection Oscillators to a lurid account of Transistors and Rectifiers.

This book has what you want. Components for the man who knows what to do with them.

The 14th Edition of the Sylvania Technical Manual is not available in any bookstore. Your Sylvania Distributor is discreet. Speak to him.

SYLVANIA
GENERAL TELEPHONE & ELECTRONICS

“Electrifying”

Circle 13 on literature card

June, 1970/ELECTRONIC SERVICING 21

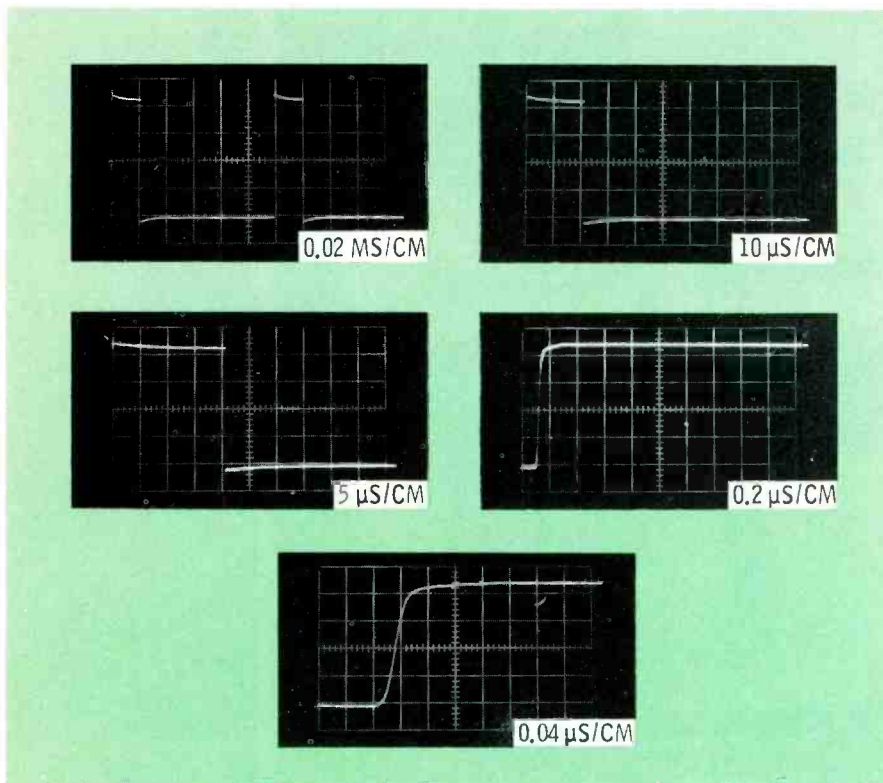

Fig. 6 Expansion of a 20-microsecond pulse as the sweep speed of a triggered-sweep scope is progressively increased.

capacitance (low-c) probe. A standard low-c probe attenuates the input signal by a factor of 10, and provides a 3-times increase of input impedance. When using the low-c probe, to read the p-p voltage of a waveform, multiply the calibrated values on the vertical attenuator by 10.

Professional-type low-c probes provide a ring or sleeve on the housing for convenient trimming of the RC probe circuit. For highly precise measurements, make this ad-

justment with the aid of a good square-wave generator before making waveform analyses. The probe is in optimum adjustment when a 15-KHz square wave is displayed with minimum distortion.

Direct Connection to Deflection Plates

It is sometimes desirable or necessary to couple signals directly to the deflection plates in the CRT, as explained previously in the article on service-type scopes (May '70 ES, pg.

12). For example, the scope used in this article has a vertical-amplifier frequency response of DC to 15 MHz; however, the horizontal-amplifier frequency response extends only to 500 KHz. Since a keyed-rainbow signal requires a somewhat greater frequency range, a vector-gram would need to be displayed by using direct coupling to the deflection plates in the CRT. Also, if it is necessary to check the modulation characteristics of a radio transmitter having a carrier frequency in excess of 15 MHz, the vertical amplifier of most scopes will be inadequate, and direct coupling to the CRT must be used.

Conclusion

Although this article has discussed the step-by-step operation of a particular triggered-sweep scope, a very basic and standard-type instrument has been chosen for the purpose. The same operating techniques that have been explained will apply with minor variations to nearly all triggered-sweep scopes.

The essential requirement for the inexperienced operator is to practice using one of these scopes. Proficiency in scope operation can be acquired only by a combination of reading and practical experience. Experienced technicians know that competence is not acquired overnight. Sufficient time must be allotted to the learning experience for the "soaking-in" process to become effective.

(An article next month will examine in detail the actual advantages and practical applications of triggered-sweep scopes in servicing consumer electronic products.) ▲

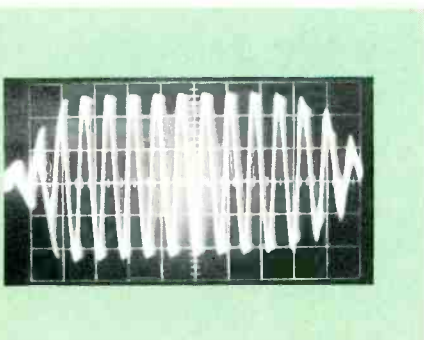

Fig. 7 Color burst expanded with a triggered-sweep scope.

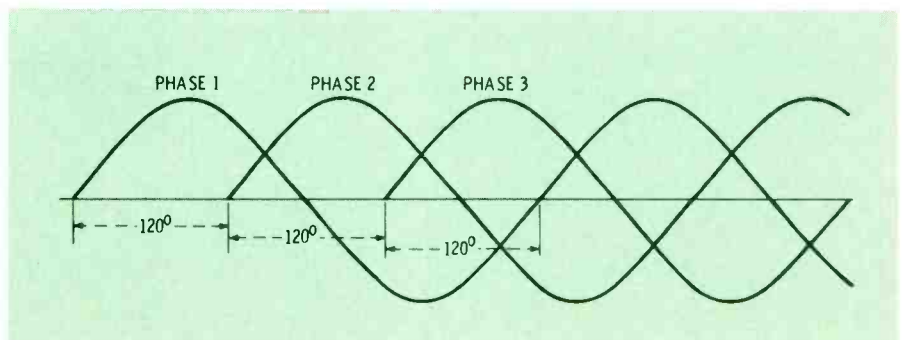
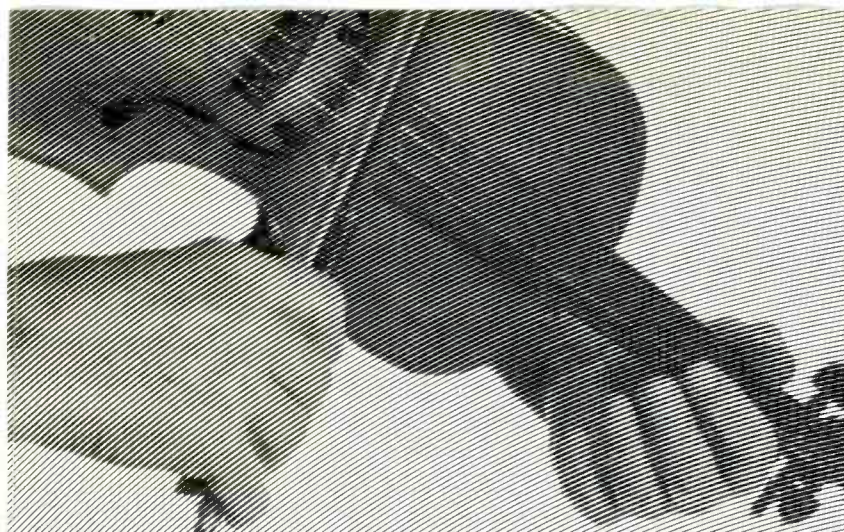

Fig. 8 Relative timing of waveforms in a three-phase system.



**professional
hands require
years of training**

**professional TV
service dealers insist on
GE ULTRACOLOR picture tubes
(made by professionals for professionals)**

GENERAL  ELECTRIC

**TUBE DEPARTMENT
OWENSBORO, KENTUCKY 42301**

by Allan Dale

Servicing the automatic turntable, Part 1

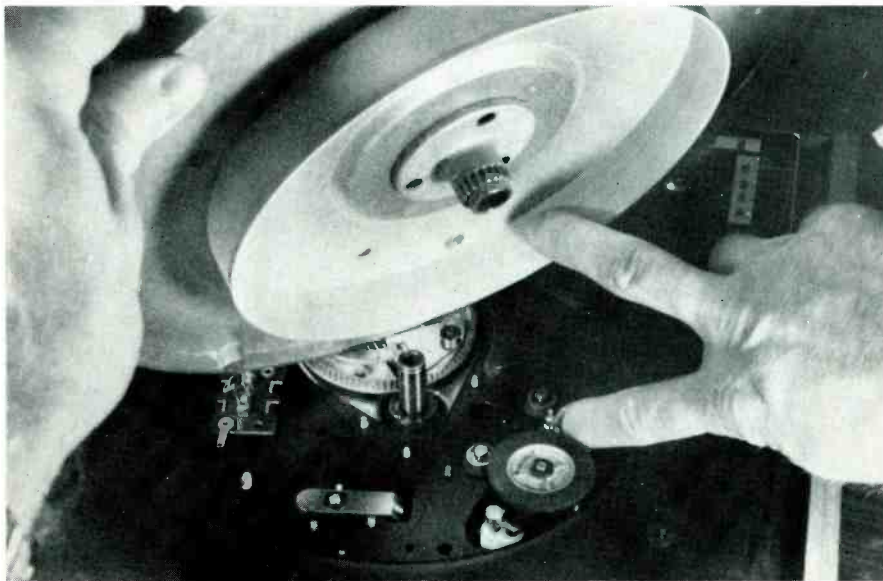
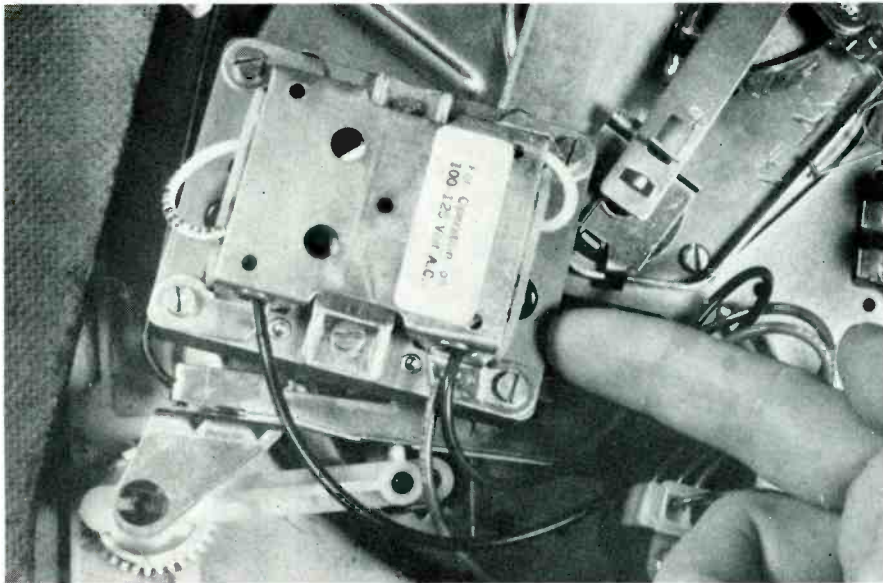

Fig. 1 Motor/drive system, showing (above) below-deck mounting of motor and drive shaft, and (below) idler above motorboard. Drive idler rotates against the turntable rim pointed out in bottom photo.

■ Automatic turntable mechanisms aren't difficult to troubleshoot; you can apply to them the same logic you use to track down trouble in electronic circuitry. Instead of thinking of **electronic** sections, stages and circuits, you think of **mechanical** operation, assemblies and motions. Once you begin thinking of them this way, the mystery about automatic turntables quickly falls away.

Automatic Operations

Start by answering the question: What does an automatic turntable do? For one thing, it spins the record—at any of four speeds. For another, it initiates a change cycle. It then moves the tone arm out of the way, drops a record, and resets the record stack in readiness for the next one to drop. It indexes the record size, to position the tone arm over the lead-in groove, and sets the tone arm down with the needle in that groove. After the final record has played, it returns the arm to its resting post and shuts off the turntable. These are **operations**.

Operations are handled by assemblies. As an example, take the matter of spinning the record. That's a simple operation, and probably doesn't really need explaining. But I'll do it anyway. It might help you see through other, more complex, operations.

The record spins because the turntable does. A motor/drive assembly turns the turntable. This assembly is the group of parts illustrated in Fig. 1. The motor is beneath the main platform (motorboard). You can see its shaft (ar-

row), with four different diameters that determine the four speeds, sticking up through the motorboard. The shaft spins against a large-diameter rubber idler, turning it. The idler fits against the drive rim of the turntable when the turntable is down over the spindle where it belongs.

Speed is changed (another operation) by a lever that raises and lowers the rubber drive idler. When the lever is at 78 rpm, the idler is at its lowest position (Fig. 2A), and presses against the largest diameter of the motor drive shaft, which rotates the turntable at the fastest speed. With the speed selector lever at 16 rpm, the idler is at its highest position (Fig. 2B), and the turntable is driven at the slowest speed.

The graduated gear wheel that raises and lowers the idler is visible in Fig. 2C. You can also see the linkage that connects it to the speed selector lever, and the teeth that twist it. Most of this assembly is made of hard, white plastic.

The explanations of these operations are simple. But they should help you understand others that follow. All the explanations are directed at helping you troubleshoot the mechanisms.

Analyzing Mechanical Trouble

The foregoing explanations partially illustrate the following proven sequence of troubleshooting:

(1) Each **operation** is accomplished by (2) a specific **assembly**. (3) The assembly goes through certain **motions**. (4) The motions are movements of **parts**. Keep these four divisions in mind: operations, assemblies, motions, parts. They are the basis of a logical technique for troubleshooting automatic turntables.

You start to service an automatic turntable by analyzing each **operation**. Once you spot a faulty one, you concentrate on the **assembly** responsible for that operation. You watch each movement or **motion** in that assembly. Somewhere among those motions is your clue to why the assembly doesn't operate as it should. Spot the missing or improper motion and you probably will see which **part** in the assembly is defective.

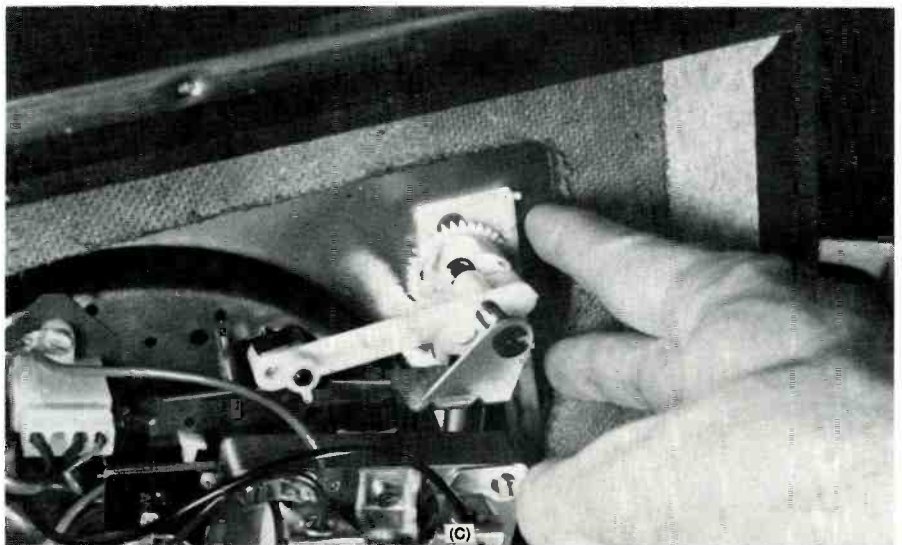
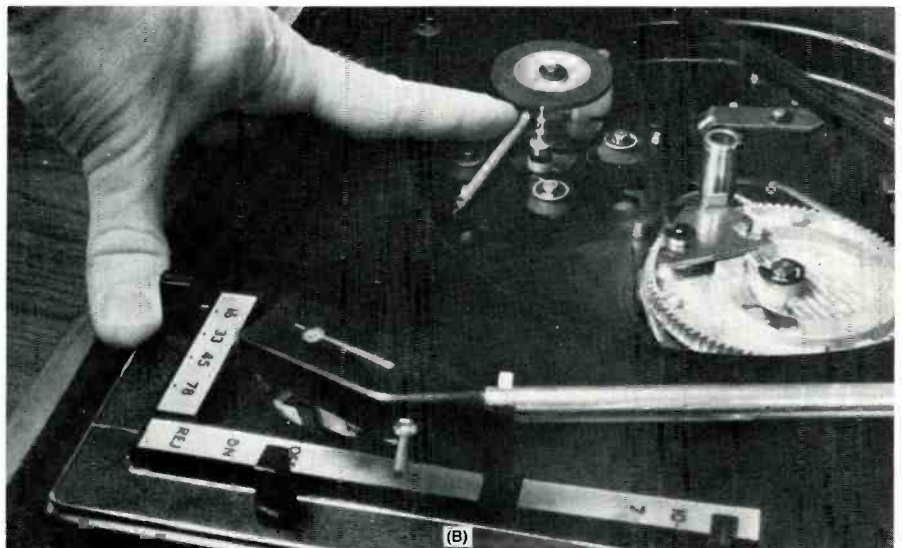
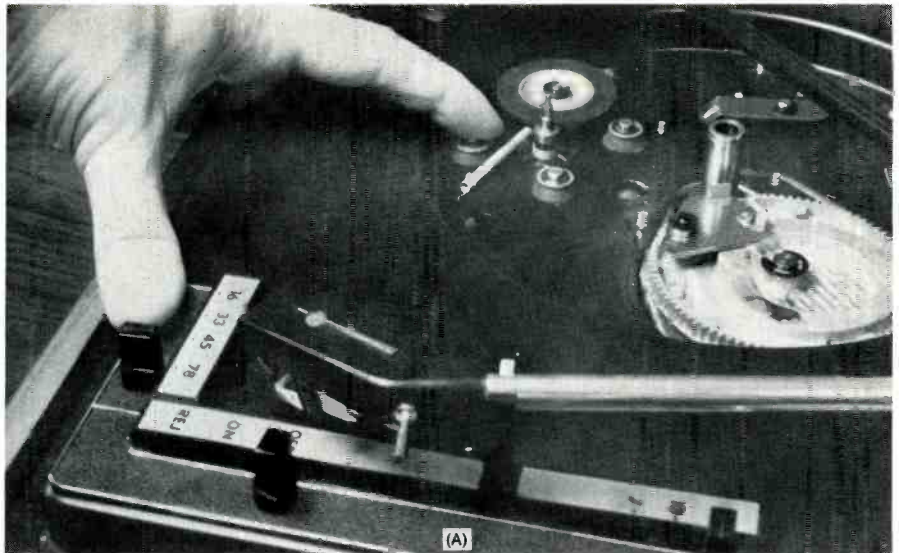

Fig. 2 Lever for changing speed (A) lowers and (B) raises a rubber drive idler. Different diameters of motor shaft turn the idler at different speeds. (C) Plastic linkage and gear that raises and lowers the idler wheel from beneath the motorboard.

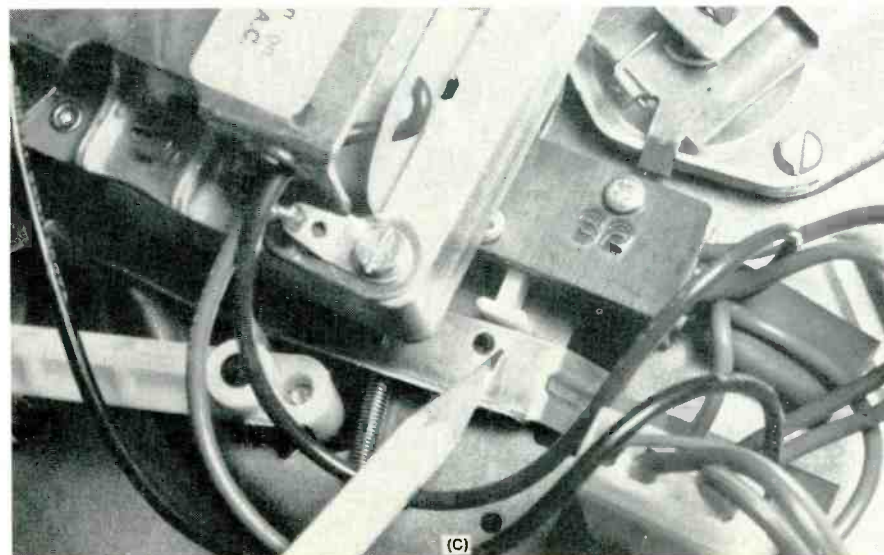
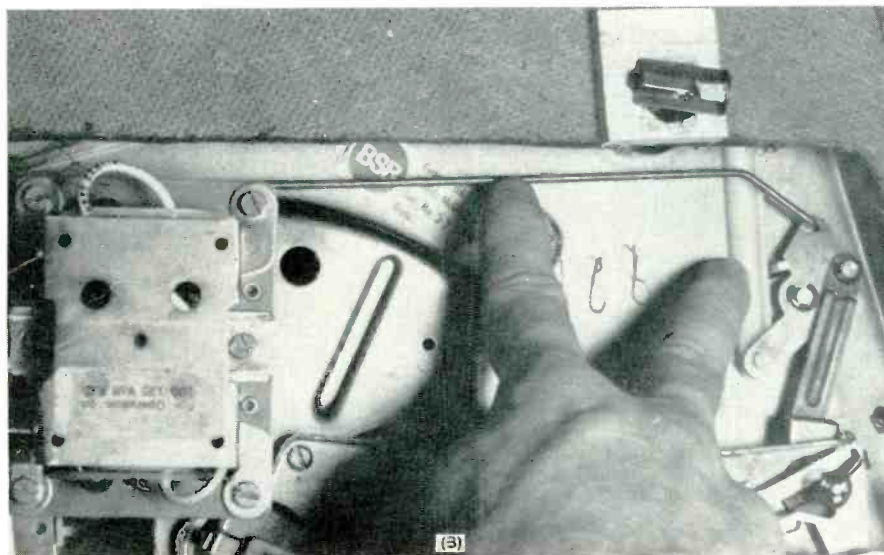
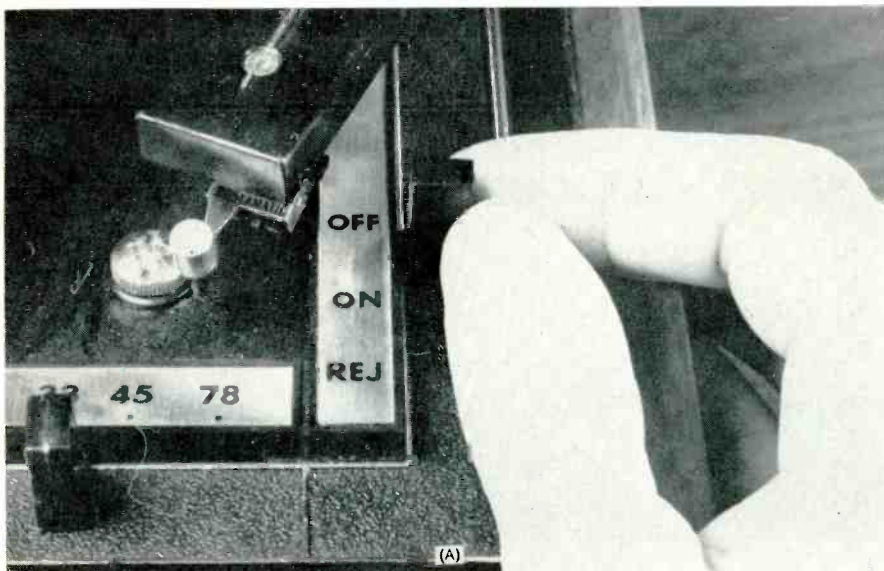

Fig. 3 Linkages that turn motor on. (A) Lever on top of board. (B) Linkages and lever below motorboard; index finger points to rod that goes to bar near motor (C) that pushes microswitch on.

The part might be bent, dirty, sticky, greasy, missing, warped, loose, or whatever. But you'll see how the fault interrupts or otherwise affects the motions in the assembly. And that's what keeps the operation from being normal.

The Drive System

Now I'll tell you more about the motor/drive system. Read this with troubleshooting in mind.

A lever on top of the motorboard (Fig. 3A) is connected by a plastic linkage to a pivoted metal lever underneath (Fig. 3B). A long, thin rod connects the pivoted lever to a flat bar near the motor. In the "on" position, that bar pushes in a micro-switch plunger (Fig. 3C). The switch applies power to the shaded-pole motor.

Failure of the motor to run could mean several things. If your voltmeter shows power is being applied, hold a screwdriver blade near the laminations of the motor. If it hums or vibrates, the windings are okay.

The armature of the motor could be stuck. To check it, remove the bolts holding the motor, and drop it down. If any oil or grease gets into the motor, it'll collect dust and eventually bind the armature. **DON'T** lubricate the motor. Clean it inside and out with ordinary alcohol. (Don't use carbon tet; it's toxic and dangerous.) If cleaning doesn't free the armature, replace the motor.

Incidentally, while you're checking in and around the motor, make sure the ground wires are tight. They're pointed out in Fig. 4. They keep the motor at the same electrical potential as the motorboard—and, through a grounding wire from the power plug, at chassis ground in the amplifier. This prevents hum in a sensitive stereo system. If you replace the motor, be sure you properly replace the ground connections.

Drive Problems

Fig. 5A is a more detailed view of the motor shaft and drive idler. The pencil points to a plastic riser that moves up and down as you move the speed lever. It raises and lowers the rubber idler wheel. You saw the underside view of this plastic assembly in Fig. 2C.

The hunt is on!

(Beware of the Grope.)

How to keep the Grope from bagging your prospects without them lifting a finger.

The Grope preys on people who don't know where to find what they're hunting for . . . turning their search for you into a jungle hunt.



The Grope footprint goes in all directions, like you without the Yellow Pages.

But you can put one over on the Grope, if you don't spread yourself thin. Cover your territories . . . all of them, by listing yourself in the surrounding area Yellow Pages.

You see, a lot of your prospects that are nearby, use a nearby Yellow Pages. And, if you're not there they miss out on you and you on them.

So play it smart and list yourself in the surrounding area Yellow Pages. After all, why try for some of the customers some of the time, when you can try for all of the customers all of the time!



The Yellow Pages

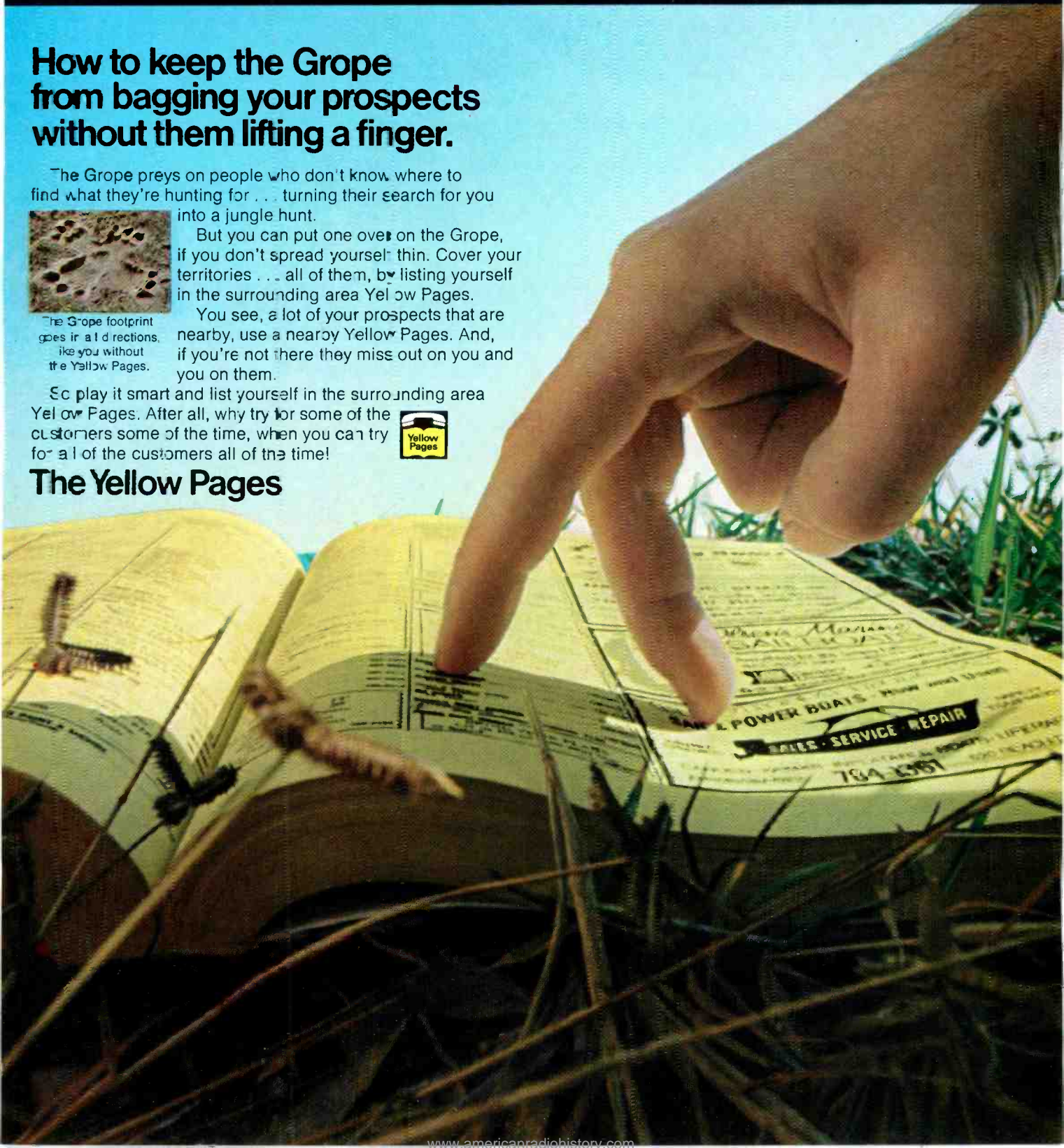
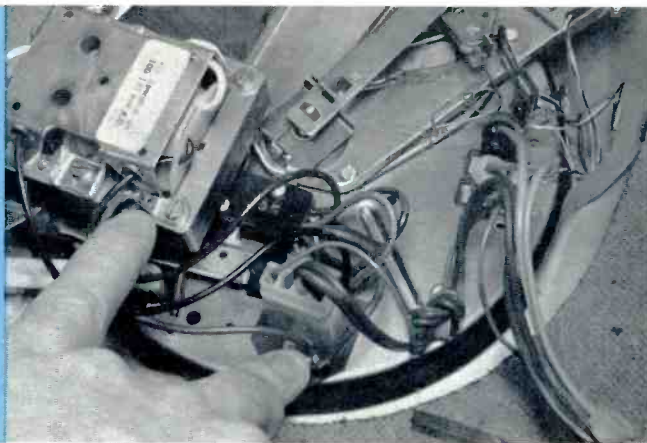
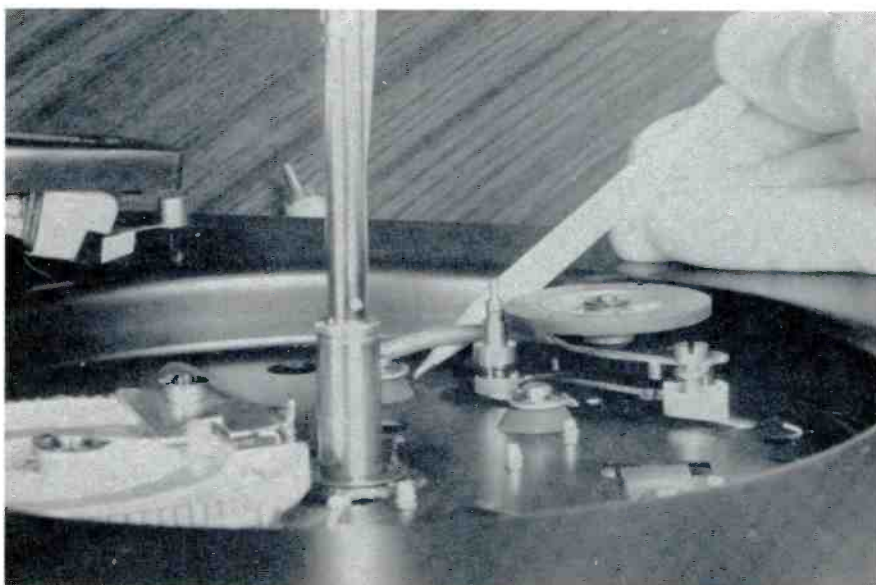

Fig. 4 Grounding wires are important in preventing hum while records are playing. Notice smaller wire in power plug; it grounds the changer motorboard to the amplifier chassis.



(A)



(B)

Fig. 5 Drive idler in 33-rpm position. (A) Plastic riser is part of mechanism pictured in Fig. 2C. (B) Spring holds idler in contact with motor shaft when switch lever is in "on" position.

The idler is in the 33-rpm position. Fig. 5B shows it contacting the motor drive shaft. You do that with the same lever that turns on the motor. A metal linkage from the pivoted lever in Fig. 3B releases the idler mounting and lets a spring hold the idler against the motor shaft. The diameter ratios, combined with the diameter ratio between the rubber idler and the turntable drive rim, reduce the 1800 rpm of the motor to exactly $33\frac{1}{3}$ rpm.

The most common trouble symptom related to the drive system is "stalling in cycle"—the change cycle starts but then hangs up. Almost invariably, this is caused by slippage in the drive system. There's a definite cleanup procedure that clears up 99 percent of such cases—if the motor is running freely. The cleaning steps are illustrated in Fig. 6.

You need a paper towel or soft cloth and some rubbing alcohol. Lift off the turntable and thoroughly wipe its drive rim (Fig. 6A). Keep applying alcohol and drying until the paper towel comes away clean.

Then turn the motor on. With one hand, hold the idler away from the motor shaft. With the other, hold the alcohol-dampened towel against the spinning shaft. Fig. 6B shows this step. Clean all the shoulders on the shaft. Then turn the motor off so the idler doesn't touch the clean motor shaft.

With a small screwdriver, pull the C-clip that holds the idler wheel in place (Fig. 6C). Remove the idler wheel from its mount (Fig. 6D). Thoroughly clean its edges and rim with alcohol. Be sure no lint from the cloth or paper towel adheres to the rubber surface. Clean the mounting spindle and the hole in the idler.

When you put the idler wheel back on the spindle, be sure the tiny fiber washers are in place. DON'T lubricate the idler spindle. Oil or graphite will work its way out to the rubber surface and cause trouble later.

Make sure the spring pulls the idler firmly against the motor shaft with the motor turned on. Be sure it works in all speed positions. Then put the turntable back in place. There now should be no stalling in-



Give them help, love, hope...

Love and guidance for forgotten youngsters, medical care for the poor and aged, counseling for troubled families...you have the power to work all these wonders. Please use it...the United Way.

✓ **Your fair share gift works many wonders THE UNITED WAY**

 28.4 million families benefit from child care, family service, youth guidance, health programs, disaster relief and services for the Armed Forces through 31,500 United Way agencies. 

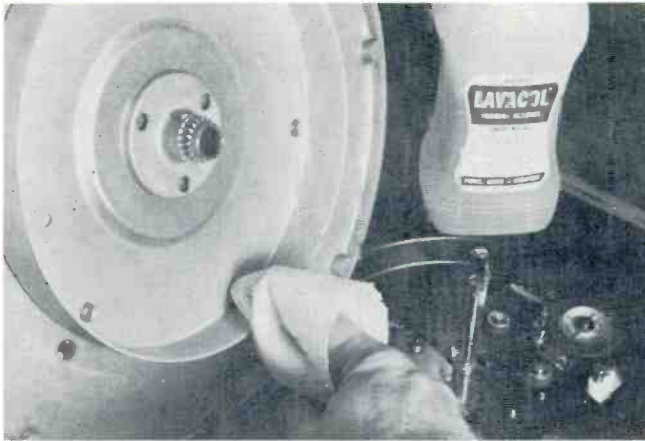

(A)

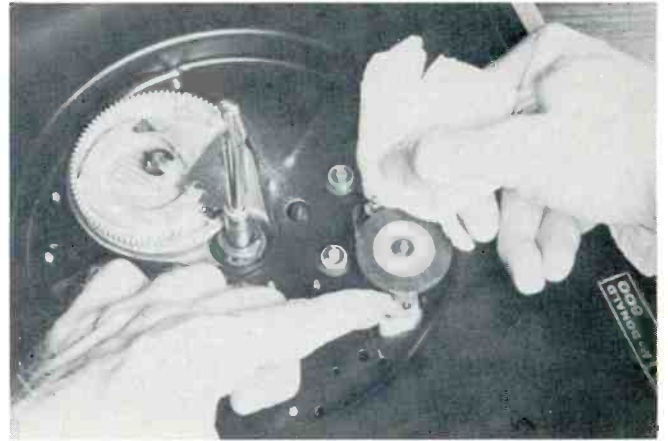

(B)

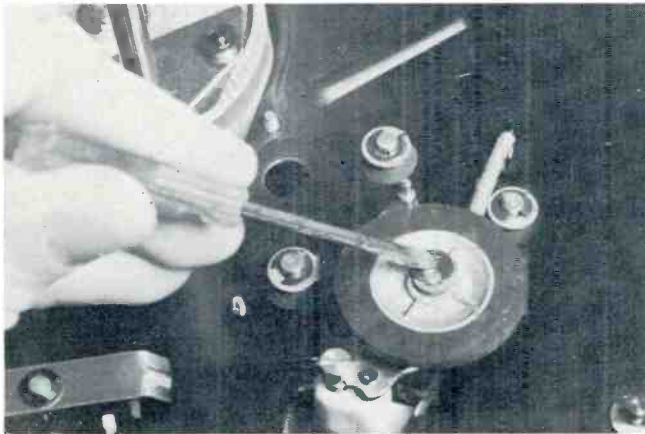

(C)

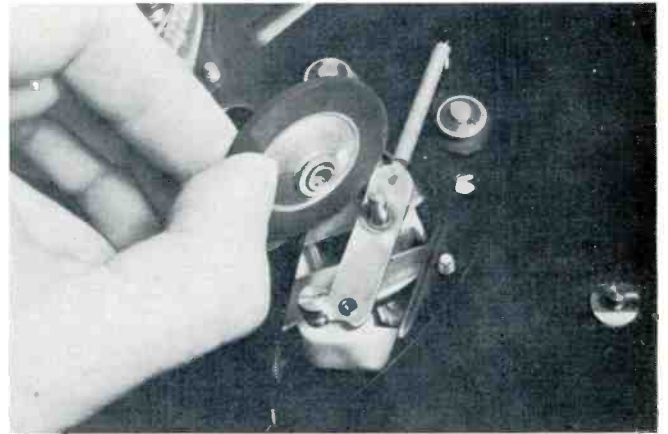

(D)

Fig. 6 Cleaning the drive system prevents stalling during change cycle. (A) Wipe turntable rim clean with alcohol. (B) Hold idler away from motor shaft and clean spinning shaft. (C) Remove C-clip holding idler and (D) remove idler. Clean it and mounting spindle.

cycle. If there is, the cycling gear or cycling slide must be causing it.

Under the Motorboard

All the cycling assemblies are beneath the motorboard. Before you get into them, make a few checks of the audio wiring.

For example, in Fig. 4 you can see the plug connections for the audio channels. If a channel is dead, this is one place to look for a broken wire. You might accidentally break one when you're working with the turntable removed.

Below the motorboard is a mut-

ing switch (Fig. 7). It shorts out both channels during the change cycle. If one of the leaves becomes bent, the tab from the cycling slide can't push the other leaves far enough to open them. You would hear no sound even when a record plays.

In the same photo, you can see the wiring. It's tiny and delicate. If you're working under the motorboard, be careful. A broken wire isn't always easy to spot. But check the wires visually—or with an ohmmeter, if you have to—both before you proceed with other repairs and again when you're finished—it's good insurance against callbacks.

Next Month

The main thing under the motorboard is the cycling mechanism. Next month, I'll explain the seven operations of the change cycle, complete with closeup photos. ▲

Fig. 7 Muting switch, if bent, can kill one or both audio channels.

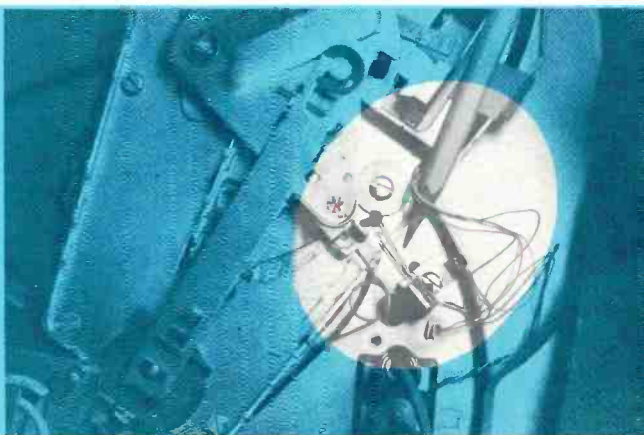

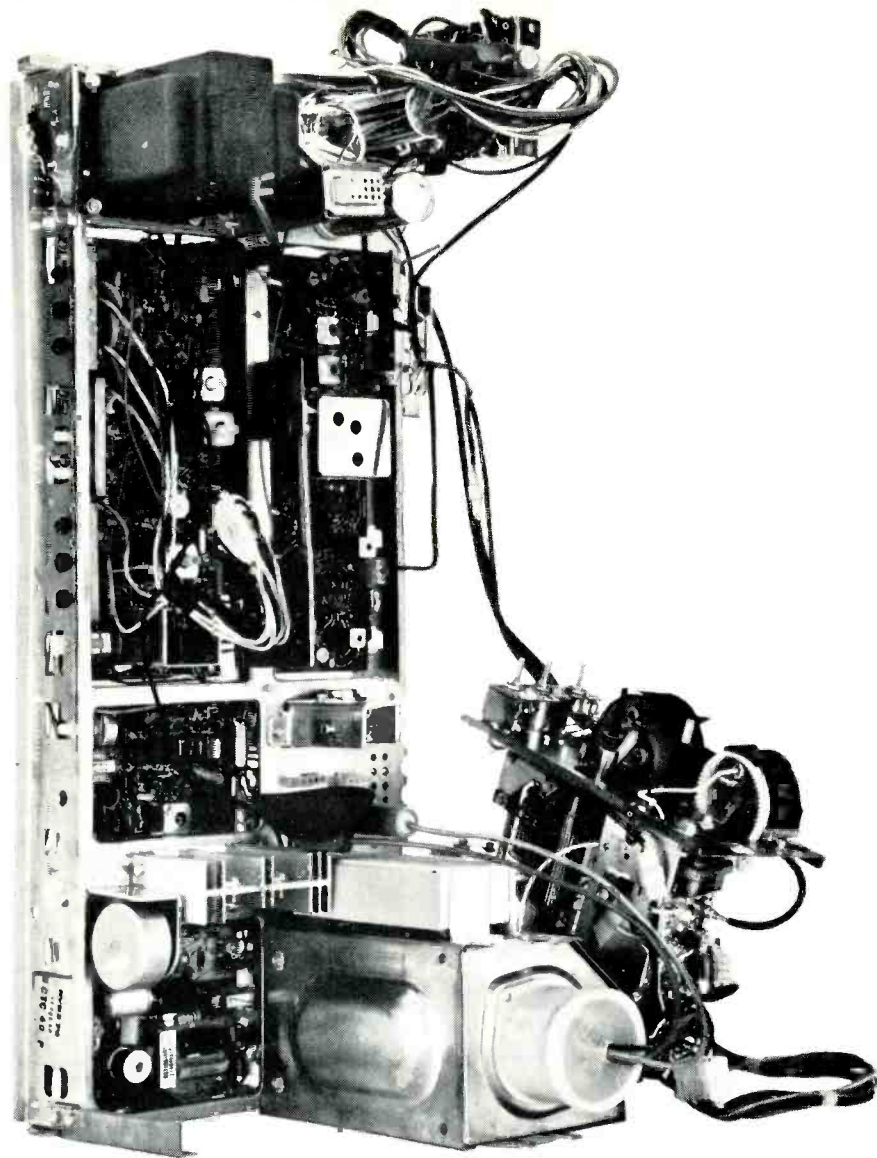

There's more here than meets the eye.

What you are looking at is RCA's solid-state* color chassis—the CTC-40.

A whole lot went into that chassis. Like fifteen years of technical research. Pioneering in the development of Solid State. And the backing of a national workshop program like nobody else's.

That's where you come in.

We've written a technical manual on the CTC-40 especially for Electronic Service Technicians. It has color

diagrams, pictures, and everything there is to know about our CTC-40.

You can buy it from your RCA Consumer Electronics Distributor, but there's a better way.

Attend the next RCA Consumer Electronics Distributor CTC-40 Workshop and get the manual free. Our distributor can tell you when it will be held next in your area. See you there.

*one tube rectifier

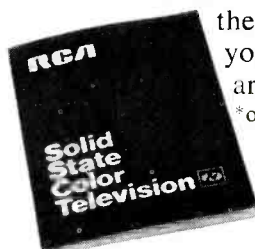

Chassis—Sylvania D12
PHOTOFACT—1045-2

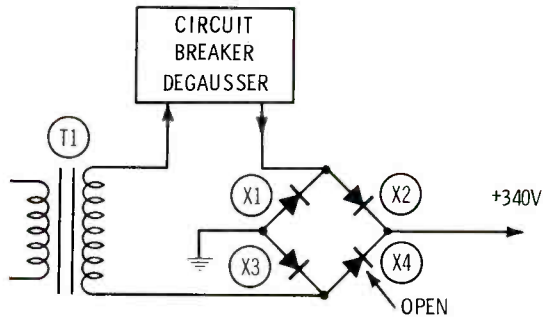

Symptom—narrow picture; purity poor; low B +
Cure—Check and, if open, replace diode X4

Chassis—Sylvania D12
PHOTOFACT—1045-2

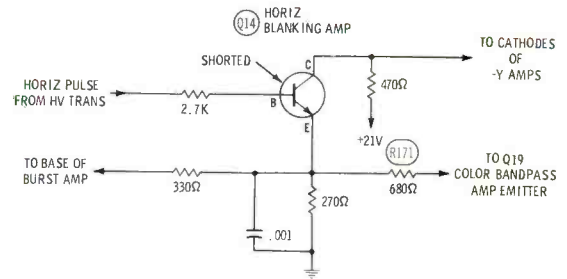

Symptom—4 or 5 dark vertical bars in raster
Cure—replace shorted horizontal blanking transistor, Q14

Chassis—Sylvania D12
PHOTOFACT—1045-2

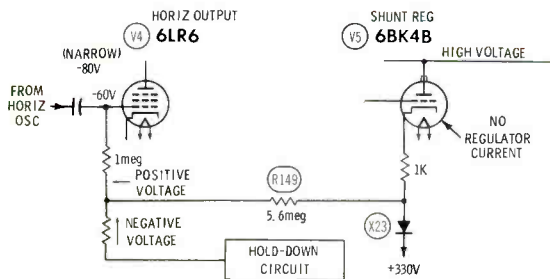

Symptom—narrow, blooming raster
Cure—check regulator current; replace 6BK4B, if weak or dead

Chassis—RCA CTC31
PHOTOFACT—928-3

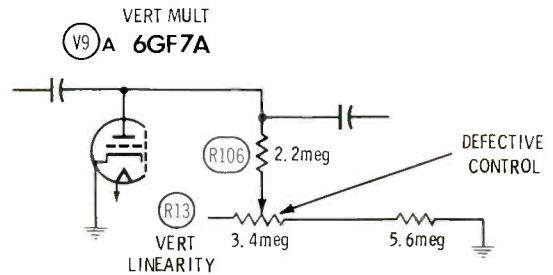

Symptom—picture height changes intermittently at top and bottom
Cure—replace vertical linearity control, R13

Chassis—Sylvania D12
PHOTOFACT—1045-2

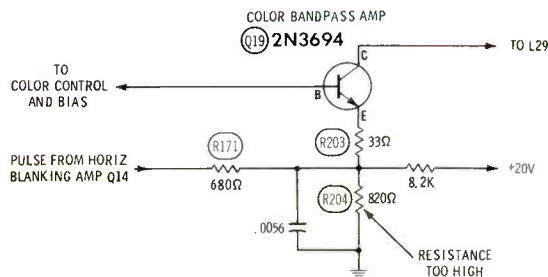

Symptom—no color in the first inch on left side of picture
Cure—check R204 (820 ohm), and replace if its value has increased

Chassis—Sethell Carlson U-806
PHOTOFACT—978-2

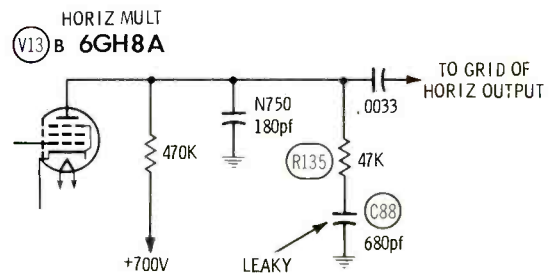

Symptom—horizontal frequency drifts, needs re-locking
Cure—check C88 for moderate leakage

Chassis—RCA CTC16X (and newer)
PHOTOFACT—818-2

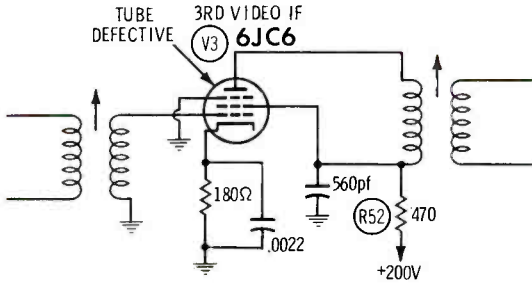

Symptom—ringing that looks like several tunable ghosts
Cure—replace 3rd video IF tube, 6JC6

Chassis—Zenith 25NC37
PHOTOFACT—869-3

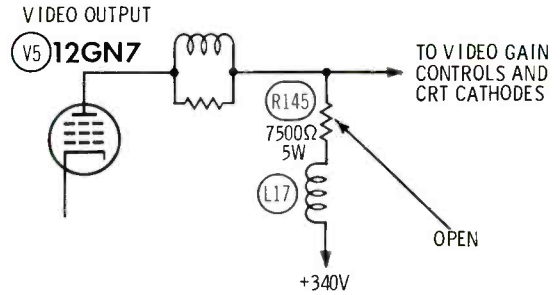

Symptom—excessive brightness; no control of brightness
Cure—check and, if open, replace R145 (7,500 ohms, 5 watt)

Chassis—RCA CTC25X
PHOTOFACT—879-3

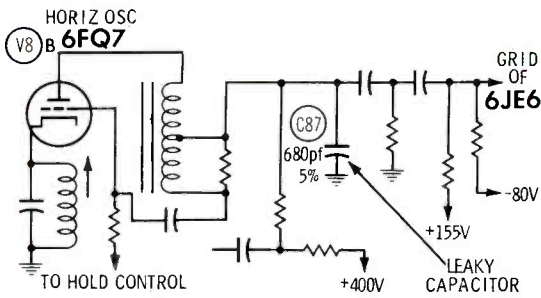

Symptom—no high voltage; 6JE6 glows red in less than a minute after set is turned on
Cure—check C87 for leakage; if defective, replace with 5% tolerance type, preferably mica

Chassis—Sylvania D12
PHOTOFACT—1045-2

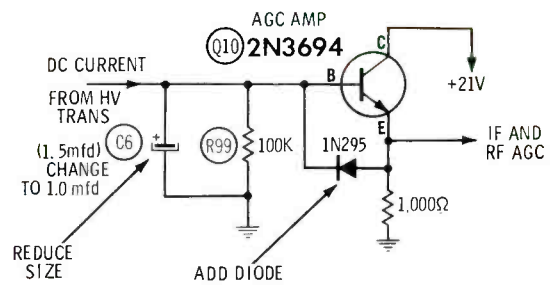

Symptom—motorboats during warmup
Cure—reduce size of C6 from 1.5 to 1.0 mfd; also add a 1N295 diode from base to emitter of AGC amplifier (if not already installed)

Chassis—Zenith 25NC37
PHOTOFACT—869-3

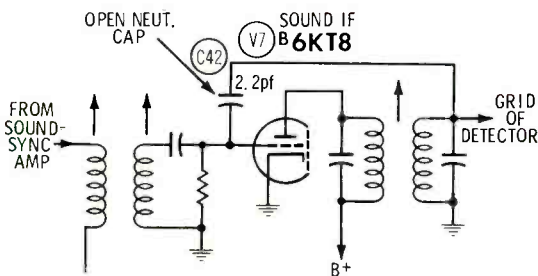

Symptom—buzz in sound; buzz control will not stop buzz
Cure—replace open neutralizing capacitor C42 (2.2 pf, 5% tolerance)

Chassis—Sylvania D12
PHOTOFACT—1045-2

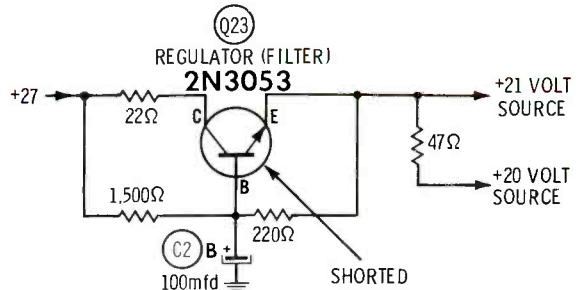

Symptom—hum bars in picture
Cure—replace shorted Q23, filter transistor

test equipment report

DC Bias Supply

New from Sencore is their "7-in-1 DC Bias Supply" Model BE156 Align-O-Pack, to be used during alignment or troubleshooting of AGC problems. The instrument can be used with tube or solid-state television receivers.

Bias supply "A" has a switch to select either positive or negative polarity, an adjustment control with a pointer knob and a voltage dial calibrated from zero to 25 volts.



Supply "B" is identical to supply "A", while bias supply "C" has two calibrated scales and three ranges: 0 to -75 volts, 0 to -25 volts and 0 to +25 volts. The four output leads are permanently attached, and are color-coded. They can be shorted together without damage to the unit.

This multiple-bias supply is operated from the power line, and has a line switch for convenience. The ripple is said to be less than .1%.

The Sencore Model BE156 DC Bias Supply is priced at \$24.95.

Circle 50 on literature card

Oscilloscope/Vectorscope

Lectrotech, Inc. has announced the availability of a high-performance, wide-band, triggered-sweep, 5-inch oscilloscope/vectorscope.

According to Lectrotech, the features include: 10-MHz bandwidth; DC amplifiers to eliminate pattern bounce and to permit viewing of AC and DC simultaneously; calibrated vertical attenuator and horizontal time base; automatic sync

mode; TV sync selector; vectorscope input for color TV servicing; external horizontal amplifier; 60-Hz



horizontal sweep with phasing control; edge-lit calibrated scale, compatible with all sweep generators; and all solid-state design except for a tube-protected input.

The unit measures 14 1/8" x 10 1/4" x 16 1/2" and weighs 23 lbs. The Model TO-50 is covered by the manufacturer's one-year warranty and is priced at \$329.50.

Circle 51 on literature card

Solid-State Electronic Multimeter

Seven DC and seven AC ranges extending from 0.5 volts to 1500 volts are features of Leader Instrument's new Model LV-77 all-solid-



state electronic multimeter. Also included are resistance ranges from 10 ohms midscale to 10 megohms full scale, and dB scales for direct power-level measurements from -10 dB to +16 dB.

Input impedance of the instrument is 11 megohms, and frequency response is 25 Hz to 1 MHz. Accuracy is $\pm 3\%$ full scale.

Other features include a DC polarity reversing switch, which makes it unnecessary to reverse test leads when testing transistor circuitry. One test probe is used for all test functions.

Price is \$89.50.

Circle 52 on literature card

Miniature-Size Tube Emission Tester

A new tube emission and shorts tester measuring 6 1/2 in. x 3 1/2 in. and weighing 4 1/2 lbs. has been announced by Mercury Electronics Corp.

The unit—equipped with compactron, nuvistor, 7-pin, 9-10-pin, octal, magnoval, novar and decal sockets—reportedly will check the emission of all tubes. The manufacturer also states that the design

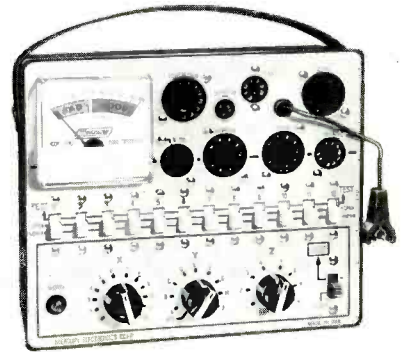

is made obsolescence-proof because 12 open-normal switches are used to set up the instrument for testing, and tube set-up data is abreast of the latest tube releases and is kept up-to-date.

Model 990 is available in kit form for \$21.95, or can be bought factory wired for \$34.95.

Circle 53 on literature card

IM Distortion Analyzer

A compact, solid-state intermodulation distortion analyzer is now available from Crown International.

Featuring accurate measuring capability through 0.01 percent, the unit guarantees a residual IM level of less than 0.005 percent, with

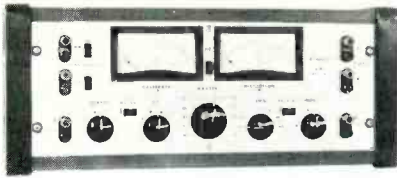

seven full-scale ranges from 100 percent to 0.1 percent. The operator sets the input level using the calibrate meter, and then reads the distortion on the percentage distortion meter. He then moves the range switch to obtain successive readings at 5 dB increments, which reportedly take under 5 seconds each.

The unit, measuring 7 inches X 19 inches X 7 inches, costs \$595.00.

Circle 54 on literature card

Megohmmeters

A new line of megohmmeters, incorporating transistorized printed circuits and self-contained, easily replaceable power sources, is available from Associated Research, Inc.

Four models of the MEG-CHEK® meters are available with megohm/ohm ranges from 0-200/0-2000 to 0-200/0-20,000/200,000.

Megohms, ohms, AC or DC volts reportedly can be measured easily without changing test lead connections. All measurements are indicated on an expanded 4½-inch scale and a lever switch permits fingertip control for both calibration and testing.

All four models are furnished ready to operate with batteries, carrying case, test leads, instruction



manual and packet of ten resistance record cards. Housed in a steel case, the solid-state units measure 8⅞ inches X 6 inches X 8¼ inches and weigh 20 lbs.

Prices range from \$165.00 to \$220.00. ▲

Circle 55 on literature card

Newest SAMS Books

Test Equipment Library

Every technician should have these famous books by Bob Middleton on his service bench. They show you how to make the best use of test equipment for fast, accurate repairs. Library consists of five volumes in slipcase:

101 Ways to Use Your VOM and VTVM Equipment

101 Ways to Use Your Signal Generator

101 Ways to Use Your Oscilloscope

101 Ways to Use Your Sweep Generator

Order 20787 (5 Vol. Set), only \$15.75



101 Questions & Answers About Transistor Circuits

by LEO G. SANDS. Answers the most commonly asked questions about transistor circuitry. Explains transistor nomenclature, biasing, the three basic circuit configurations, input and output impedances, current and voltage gain, and other basic considerations. Also gives the counterparts of tube applications. Covers power supplies and circuits; af circuits; rf circuits, and oscillators. Order 20782, only \$3.50

Security Electronics

by JOHN E. CUNNINGHAM. Explains the operating principles of modern electronic devices and systems used to provide security against crime. Describes intrusion alarms and intrusion-detection devices. Includes chapters on the detection of hidden metal objects, announcement of detected intrusions, bugging, debugging and speech-scrambling systems, and future developments. Enables the technician to apply his experience to this rapidly expanding new field. Order 20767, only \$4.50

Transistor-TV Servicing Made Easy

by JACK DARR. This practical guide, based on tried and proved shop experience, will help you become skilled in the special techniques of transistor-TV servicing. Covers the tools and equipment you will require; transistors and transistor-servicing techniques; power supplies; horizontal and vertical sweep circuits; video i-f and output circuits; agc and sync-separator problems; tuners; audio circuits; and selecting replacement transistors.

Order 20776, only \$4.95

Mobile-Radio Systems Planning

by LEO G. SANDS. Here is practical, basic information about various types of mobile-radio systems, how they work, their capabilities and limitations, system requirements, licenses, channels, band and frequency selection, transmitter-receiver selection, antenna systems, and accessories. Includes an invaluable system-requirements form for planning a mobile-radio system.

Order 20780, only \$4.50

HOWARD W. SAMS & CO., INC.

Order from your Electronic Parts Distributor, or mail to Howard W. Sams & Co., Inc., Dept. ES-6
4300 W. 62nd St., Indianapolis, Ind. 46268

Send books checked at right. \$_____ enclosed

Send FREE 1970 Sams Book Catalog

20776

20787

20782

20767

20780

Name _____
PLEASE PRINT

Address _____

City _____ State _____ Zip _____

Circle 16 on literature card



Selecting replacement resistors

Characteristics and considerations

Rules-Of-Thumb About Resistor Failures

My observations over a period of years seemed to reveal that carbon-composition resistors with a dissipation

rating of 1 watt or less are more susceptible to unexplainable value changes than are similar resistors with larger dissipation ratings, even when all are operated

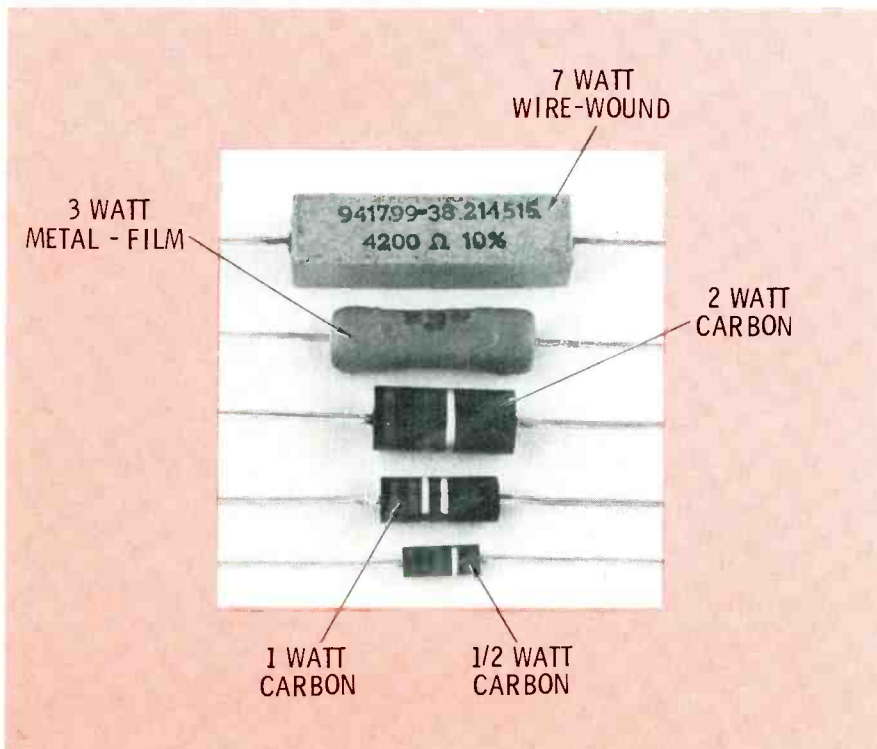

Fig. 1 Comparison of size and appearance of different wattage carbon-composition, metal-film and wirewound resistors.

within their ratings and are not damaged by overloads. This appeared to be especially true of resistors with values in the megohms.

Many other experiences indicated that the values of resistors subjected to moderate overloads usually **increase**, while the values of resistors that have been severely overloaded often **decrease**.

These observations and experiences were condensed into practical "rules-of-thumb", which were of great value to me in servicing. But questions arise, such as: Is there really any technical proof of these conclusions? I decided to find out for certain by performing the following experiments.

Resistor Damage Caused By Heat

To simulate the change in heat during the receiver's on and off periods, several resistors were measured using an ohmmeter, then were heated by applying a 40-watt iron to the leads. This is the approximate amount of heat that ordinarily would be used to solder them into a circuit. Their resistance was measured while they were hot, and again after they had cooled to room temperature (sometimes speeded up with cooling spray). This sequence was repeated several times.

One resistor, marked 150 ohms/½ watt and measuring 145 ohms, increased to 170 ohms when heated, decreased to 151 ohms when cooled and 3 heating cycles later stabilized with a cold resistance of 162 ohms, or about 12% higher.

A 1-watt resistor measured 230K ohms at the start, 300K ohms when hot, and after 3 heating/cooling cycles, the cold resistance was 270K ohms, or about 17% higher.

A 10K-ohm, 2-watt resistor measured 11K ohms hot, but returned to a normal 10K ohms after several heat cycles. Fig. 1 shows a comparison of the size of these resistors.

The worst example was a .5-watt resistor which originally measured 3.4 megohms. When the leads first were heated with a soldering iron, the hot resistance was above 4.5 megohms, and decreased to about 4 megohms after cooling. After three heating and cooling cycles, the resistor measured 5 megohms, about 47% high, at room temperature.

Of course, the hottest temperature these resistors were subjected

to probably is above the average encountered in typical receiver operation. But the results check closely with past cases of receivers operated for several months or more. None of the resistors showed the slightest visual signs of overheating.

Another .5-watt resistor was overloaded and tested to destruction by applying DC voltage and current to furnish the wattage specified. Here are the results:

- 149 ohms cold—.5 watt applied for 2 minutes—155 ohms hot
- 150 ohms cold—1 watt applied for 2 minutes—160 ohms hot
- 154 ohms cold—1½ watts applied for 2 minutes—163 ohms hot
- 155 ohms cold—2½ watts applied for 2 minutes—170 ohms hot

Note: At this point, the resistor began to smoke and the color code faded (Fig. 2).

- 152 ohms cold—3½ watts applied for 2 minutes—150 ohms hot
- 117 ohms cold—4 watts applied for 2 minutes—67 ohms hot
- 56 ohms cold—resistor was discolored, had a burned odor and the color-code stripes were burned off.

Notice that the resistance increased as the wattage was increased—up to a point. Beyond that, the resistance decreased with further overload. These experiments con-

firmed my previous observations about carbon resistor failures.

Less Heat-Sensitive Resistors

A 5 meg-ohm, 1-percent precision resistor of unknown internal construction also was subjected to hot and cold cycles. When heated, the resistance decreased. This is negative temperature coefficient, and is unusual since most resistors have a positive coefficient. There was no change in the cold resistance after the heat/cold cycles.

Ordinary wirewound and evaporated metal-film types of resistors showed no significant change in resistance when heated and no permanent change in value after temperature testing.

Tips for Replacing Resistors

Here are some recommendations to consider when replacing resistors:

- If the defective resistor is a carbon-composition type, replace it with the next higher wattage (space permitting), or with a more stable type, to increase the dependability.
- Minimize heat at the resistance element during soldering. Use a temporary heat sink, or leave longer leads on the resistor, if it is not used in a super-critical tuner, IF or oscillator circuit. Better yet, frost the body of the resistor with circuit cooler just before soldering the leads. Similar cooling is recommended for transistor soldering, too. No heat sink is needed for either

resistors or transistors when this method is used.

- Do not install a carbon resistor too near a source of heat, such as a high-wattage resistor; the resultant heating and cooling might change the resistance value until it is out of tolerance. This is of particular importance with resistors whose values are in the megohms.

- Do not use a carbon resistor to replace a metal-film or wirewound type.

- A carbon resistor that has been overheated to the point where its value increases should be replaced, because it might change resistance even more with continued usage. The same recommendation applies to resistors which have been badly overloaded and measure low.

- Matched pairs of resistors in a color receiver should be within 1 percent of the value of each other, but they need not be that close to the marked value. (Matched resistors often are used as grid resistors in 6BK4 high-voltage regulator circuits, phase and color-killer detectors, and the plate (or collector) load resistors of color demodulators.) If one resistor of a matched pair is defective, replace **both** to make certain they are the same brand and, therefore, have the same temperature coefficient.

- Two or more resistors can be wired in series or parallel to obtain values you do not have in stock, or to increase the wattage rating. If the resistors are identical, the wat-

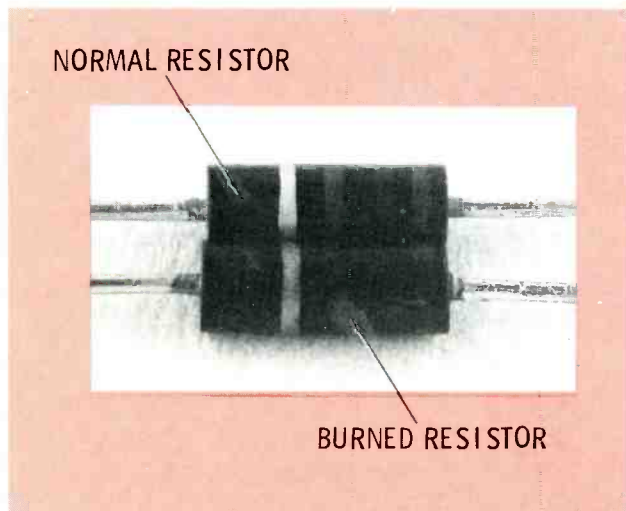

Fig. 2 First evidence of an overloaded resistor is disappearance of the color-code stripes.

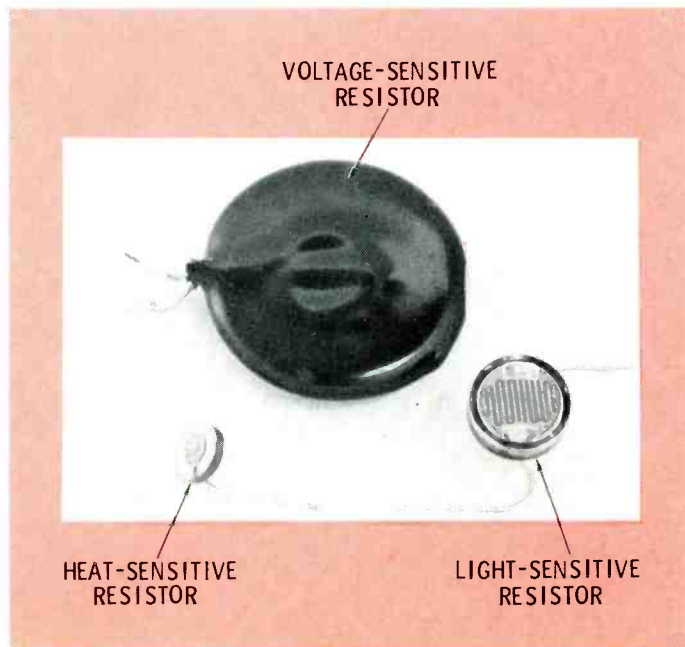

Fig. 3 Various types of special-purpose resistors include heat-sensitive, voltage-sensitive and light-sensitive resistors.

tages are equal and add correctly. But watch out for some pitfalls in the wattage obtained from unequal resistors. For example, suppose you want to connect a 10K-ohm and a 30K-ohm resistor in series across 200 volts. Each resistor is rated at 1 watt. Does this produce 2 watts of total maximum dissipation? Solving for wattage using the "P=voltage squared divided by resistance" formula, we find the 10K-ohm resistor dissipates .25 watt, and the 30K-ohm unit dissipates .75 watt, three times as much as the 10K-ohm resistor. On the other hand, two parallel resistors, one a 2-watt resistor and the other a 1-watt, can dissipate a total of 3 watts if the 2-watt resistor is 1/2 the value of the 1-watt resistor (and, of course, if the total parallel resistance of the two is correct for the intended use).

Special-Purpose Resistors

One of the present trends in electronic manufacturing is the use of special-purpose resistors, such as those shown in Fig. 3. These resistors include:

- **thermistors**, or heat-sensitive resistors, which have a strong negative-temperature coefficient; their resistance decreases greatly when the resistor becomes hot. In some applications, the hot resistance will be only about 10% of the value of the thermistor at room temperature. Thermistors are used to stabilize the bias on transistors, reduce the current in a degaussing coil, or change the voltage applied to an oscillator to minimize thermal drift. The schematic component symbol includes the letter "T", for thermal.

- **varistors**, or voltage-sensitive resistors. A varistor's resistance is reduced as the voltage across it is increased. They are used to stabilize some low-current voltage sources, such as the B+ supply for oscillators or other critical circuits. When supplied with pulses or other non-symmetrical waveforms, a varistor acts as an inefficient (but very rugged) rectifier. They are sometimes called voltage-dependent resistors, and a "V" is included in the schematic component symbol.

- **light-sensitive resistors**, or "LDR", or light-dependent resistors.

These are usually of the cadmium-sulfide or cadmium-selenide type, whose resistance greatly decreases with an increase in the amount of light shining on the cell. These were very popular a few years ago in automatic brightness and contrast circuits. An "L", indicating that it is light-actuated, is added to the normal resistor symbol.

- **zener diodes**. When used as a DC voltage regulator, a zener acts precisely as a variable shunt resistor. A higher voltage applied across the zener decreases its resistance, thus holding the voltage across it constant to within a few tenths of a volt. The diode symbol is used with the two ends of the center line turned in opposite directions.

These special-purpose resistors preferably should be replaced with units that have specifications identical to the original.

Next Month

In *Shop Talk* in the next issue, we'll look at capacitor characteristics that are important to servicing, plus tips on capacitor substitution.



You asked for it . . . and PHOTOFACT gives it to you. MODULAR HI-FI SERIES



Service data covering popular compact stereo, component hi-fi, modular hi-fi and AM-FM multiplex compact units—domestic and foreign units. Each volume of the MODULAR HI-FI SERIES provides **complete** coverage of 10 to 15 popular models. 10 to 12 volumes per year provide blanket coverage of the most popular units.

QUICKER SERVICING data from PHOTOFACT, a division of Howard W. Sams & Co., Inc. . . . leading publisher of timely and accurate electronic servicing information for nearly a quarter of a century

PHOTOFACT
ELECTRONIC SERVICING
HOWARD W. SAMS TECHNICAL
BOOKS
COUNTERFACTS

audio systems report

Audio Control Centers

Audio control centers, which allow up to 4 or 6 stereo speaker systems to be selected for simultaneous operation, have been introduced by ALCO Electronic Products, Inc.

"Push-ON and push-to-RELEASE" switches reportedly allow the user to select the speaker systems of his choice, whether it is one or up to six speaker pairs to be placed in operation. Three types of rear-panel connectors are available to match the user's system.

No external power is required for operation, according to the manufacturer. Magitran also states that



no internal resistors that may affect impedance matches are included, and the systems are useable in either low- or high-impedance circuits.

Models series CC4 control up to four channels, and Models series CC6 up to six channels. Each series has three models: one for RCA jacks, one for miniature phone jacks, and one for standard phone jacks. The units measure 2 1/8 in. X 5 5/8 in. X 3 1/8 in., and range in cost from \$19.95 to \$29.95.

Circle 60 on literature card

Disposable Tape and Record Wipers

New lint-free, disposable cleaning "cloths" for recording tapes and



records are available from Robins Industries Corp.

Impregnated with a special formulation, the "cloths" wipe records and tapes clean and deposit a microscopic film of silicone. The "cloths", which actually are made of a non-woven, lintless cellulose material, are sized for the respective applications. They are discarded when soiled or dry from use. To insure cleanliness and storage life, they are individually packaged.

Peg packs of 18 disposable "cloths" list at \$1.65. The tape version is catalogued as TG18, the disc size as PG20.

Circle 61 on literature card

Tape Eraser

A new dual-purpose tape eraser has been made available by Audiotex Products of the GC Electronics Division of Hydrometals, Inc.

Model 30-140 can be used by hand or as a table unit. Operation of the unit as a table model is accomplished by placing the tape reel



on the reel post and rotating. Hand-held, the eraser is passed over the tape reel in a circular motion.

The tape eraser, including a "momentary" switch and cord, is priced at \$18.30.

Circle 62 on literature card

Tape Player Head Cleaners and Testers

Cassette and cartridge head cleaners are now available from Robins Industries Corp.

Two combos, three-in-one "Test-

N-Clean" cassette Model THC-6 and cartridge Model THC-8, reportedly remove accumulated oxide, grime and foreign matter, and also test heads for both alignment and stereo balance between channels. Each combo sells for \$2.80.

For more gentle head cleaning, a lintless, non-woven polyester cloth, "Head-Kleen" cassette Model



THC-4, is available and sells for \$3.00. The "Head-Kleen" cassette Model THC-7 cleans by means of polishing tape, and is priced at \$2.50.

Circle 63 on literature card

Portable/Mobile PA Systems

A series of 16 portable/mobile public-address systems, reportedly designed for quick set-up and operation at both indoor and outdoor functions, have been announced by Bell P/A Products Corp.

The amplifiers and speakers in each system are sized and matched

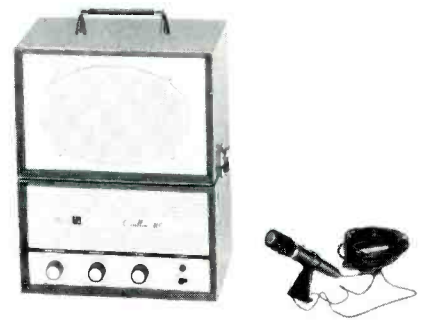

for particular crowd capacities, according to the manufacturer. All systems, except the "Car-Top 30", a 30-watt, all weather car-top system with mounting bracket, include a carrying case with handle.

Prices range from \$160 for the "Portable 10", a 10-watt system, to \$350 for the "Portable 35". ▲

Circle 64 on literature card

**For more information
on above products
use reader service card**

No Horizontal Locking

Another shop gave up on this RCA KCS136X chassis (PHOTOFACT 746-4) and by the time it reached here the wiring had been altered. I found and repaired two troubles, but one bad one still remains—horizontal slipping. All scope waveforms and peak-to-peak measurements around V10 are normal. New tubes have been substituted, and the duo-diode, X4, has been replaced. Any ideas?

Robert Steely
Reading, Pa.

You do not indicate that the horizontal sync can be locked in, even momentarily, so we'll assume it can't, and the picture drifts across the screen. You have already tested or replaced any parts that are typical troublemakers in this model, so we'll describe a series of tests which should find the source of the problem.

Check the peak-to-peak waveforms at X4. Does the sawtooth at terminal 1 measure over 20 volts. Does the waveform and amplitude at terminal 2 correspond with those in PHOTOFACT? This sawtooth part of this waveform is a feed-through from terminal 1, so we are interested mainly in the sync pulse that adds

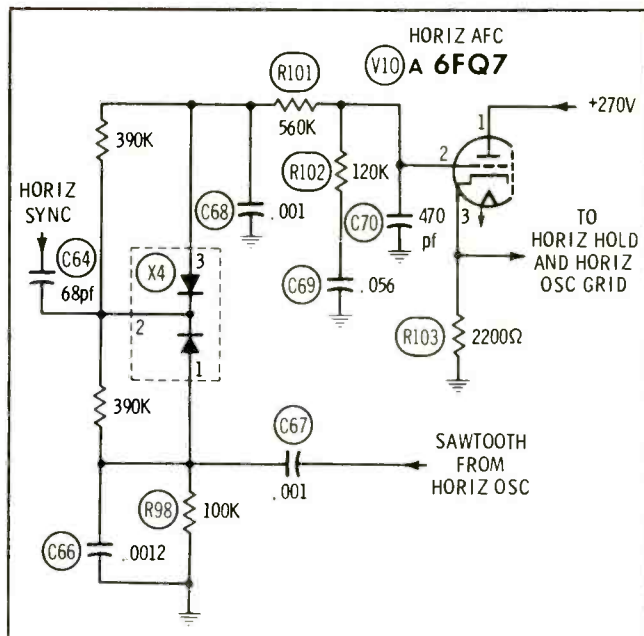

a small spike at the bottom of the sawtooth. Is it there? If either the sawtooth at terminal 1 or the sync pulse at terminal 2 is missing, there can be no locking.

An error-correction DC voltage is developed at terminal 3 of X4 when the sync and sawtooth are not in phase. With the picture slowly flipping sideways, you should be able to measure a varying DC voltage at terminal 3. This voltage might go up to a couple of volts positive, down to zero, farther down to two volts



DECISION MAKER

The Sencore CRT Champion. Judge and jury when it comes to color CRT analyzing. Reaches a verdict in seconds — tells you if the tube has adequate emission, and if it will track in the TV set.

Automatic color tracking according to industry standards with exclusive 3 Gun G2 Control.

One-step controlled rejuvenation with automatic RC timer. A Sencore exclusive.

Lots more, too. So try the decision maker — the Sencore CRT Champion — at your distributor today. You'll reach the right verdict. \$119.50



SENCORE

NO. 1 MANUFACTURER OF ELECTRONIC MAINTENANCE EQUIPMENT

426 SOUTH WESTGATE DRIVE, ADDISON, ILLINOIS 60101

Circle 17 on literature card

NEED CRYSTALS?

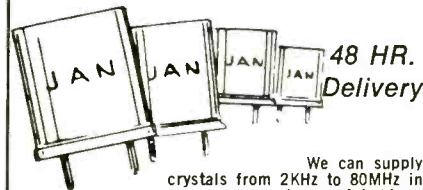

We can supply crystals from 2KHz to 80MHz in many types of holders.

SPECIALS

Color TV crystal (3579, 545KHz) wire leads\$1.60; 4 for \$5.00
100KHz freq. std. crystal (HC13/U)\$4.50 (HC13/U)
1000KHz freq. std. crystal (HC6/U)\$3.50
Any CB crystal, TR. or REC. except synthesizer crystals\$2.25
Any amateur band crystal (except 80 & 160 meters)\$1.50 or in FT-243 holders
Any marine frequency (HC6/U)\$2.85
80 meter—FT243 holders\$2.50

We have in stock over six million crystals which include types CR1A/AR, FT243, FT241, MC7, FT249, HC6/U, HC13/U, HC25/U, HC18/U, etc. Send 10¢ for our 1970 catalog with oscillator circuits, listing thousands of frequencies in stock for immediate delivery. (Add 10¢ per crystal to above prices for shipment 1st class mail, 15¢ each for air mail).



Special Quantity Prices to Jobbers and Dealers
ORDER DIRECT with check or money order to:

2400 E. Crystal Drive
Fort Myers, Florida 33901

Circle 18 on literature card

negative, back to zero, up to positive 2 volts, etc.

If the DC voltage is not there, C68 might be shorted, X4 might be defective, or the waveforms at terminals 1 or 2 of X4 may be missing.

If this voltage does vary, then measure it at the grid (pin 2) of V10A. The same varying DC voltage should be there, too, perhaps just slightly lower in amplitude. If the voltage is not present on the grid of V10A, C70 or C69 might be shorted, V10A might be gassy, or R101 open.

V10A is a cathode follower, which means the cathode voltage "follows" the grid voltage quite closely. The cathode voltage at pin 3 should vary like it did at the grid; however, it will do so around a center point of about positive 10 volts instead of zero.

If the cathode voltage of V10A is zero, the tube is dead, has a cathode-to-heater short, one of the socket pins is open, or the plate voltage is missing.

If the voltage is about 20 volts positive, and doesn't vary much with the varying grid voltage, the cathode resistor, cathode socket connection or associated wiring is open; carefully measure it with an ohmmeter.

The voltage at the cathode (pin 3) of V10A is connected to the grid of the oscillator through the horizontal hold control, to automatically change the horizontal oscillator frequency when all is functioning normally. Loss of horizontal locking must be caused by defects in the circuit just described, and *cannot* be caused by the horizontal oscillator itself. With small changes, this troubleshooting method also works

with other makes and models.

Drifting Horizontal Bar

A bright horizontal bar appears on the screen of a Philco 17QT85A color chassis and moves slowly to the top of the screen, reappears at the bottom and drifts to the top again and again. Can you help me locate the cause of this defect?

Robert Zagrabelny
Marshall, Mo.

In my file, this is listed as a recurrent problem caused by internal leakage in C3, a 4-section filter capacitor. The leakage transfers some of the 60-Hz ripple from the 18-volt power supply to the cathode of the 12GN7 video tube. Replacement of the entire filter capacitor can be recommended.

Substitute For 3B2

The 3B2 needs to be replaced in an old Emerson Model C506A color set. According to substitution books, the 3A3 should work as a substitute, but it does not. What can I do to make a 3A3 operate in this set?

Norman Pichette
Auburn, Maine

My guess is that an internal jumper is shorting across the 3A3 filament when the tube is plugged into the socket.

Both the 3B2 and 3A3 have the same base wiring, while the 3A3 has higher plate voltage and current

THE BEST PERFORMING UHF/VHF 2-WAY AND 4-WAY HYBRID SPLITTERS



#HS-20U 2-Way



#HS-40U 4-Way

RMS engineered for Master Antenna Systems and Multiple Set Home Installations. Impedance all terminals: 75 ohms unbalanced. Fittings: F type with Ferrule for RG59/U cable. Capacitive AC/DC isolation. Each unit includes F type RG59/U cable connectors and two wood screws for indoor surface mount.

TOP PERFORMING UHF/VHF TAP-OFFS



Single 300 ohm output from 75 ohm feed-thru line. Push-on fittings for RG59/U cables. Wood screws for indoor surface mount provided.

For Unbelievable—yet true ratings and Profit details—Write—

RMS ELECTRONICS, INC.

50 Antin Place, Bronx, N.Y. 10462

Tel. (212) 892-6700

See us at Consumer Electronic Show — A507 Americana.

Circle 19 on literature card

Little GIANT



SENCORE CG19 CADDY BAR COLOR GENERATOR

Small enough, light enough to carry right in your tube caddy—so you have it handy on every color TV service call.

Little giant in performance. All crystal controlled standard RCA licensed color bars, crosshatch, white dots, vertical lines, horizontal lines. Rock solid or your money back.

New circuitry. Less current drain permits full voltage regulation on all circuits, and increases battery life.

Timer range doubled over previous models.

Lowest priced unit available, \$84.50 All Domestic Made

IN STOCK AT YOUR LOCAL PARTS DISTRIBUTOR.



SENCORE

NO. 1 MANUFACTURER OF ELECTRONIC MAINTENANCE EQUIPMENT

3200 Sencore Drive, Sioux Falls, South Dakota 57100

Circle 20 on literature card

June, 1970/ELECTRONIC SERVICING 41

ratings. On paper, it seems the 3A3 would be an ideal replacement for the 3B2. However, first check for internal jumpers inside the tube in relation to the tube socket pins that are tied together. PHOTOFAC indicates that pins 1-3-5-7 are connected, with pins 2-6-8 wired to the other end of the filament. The RCA tube manual shows no internal jumpers in their 3A3, but other brands might have some of the tube prongs tied together internally.

Use your ohmmeter to find out if your 3A3 has any internal jumpers, then disconnect any socket pins that conflict with the jumpers.

Horizontal Blanking Bar in Center of Screen

After correcting the main complaint in a Zenith 16J23 b-w TV chassis, the picture developed "pie crusting". A visual examination revealed the C53 had been removed from the circuit. After installing a new C53, the picture was straight but would lock correctly only with the horizontal blanking bar in the center of the picture. The duo-diode and horizontal control tube, V9, have been replaced. Also, the sync and feedback pulses at the duo-diode look normal on the scope.

I replaced C50A, C50B, C51A, and C51B and C52. Also, R74, R75, R76, R77, R80 and R90 were checked or replaced, if they were off tolerance at all. No change in the symptoms.

When I disconnect C53, the picture locks properly,

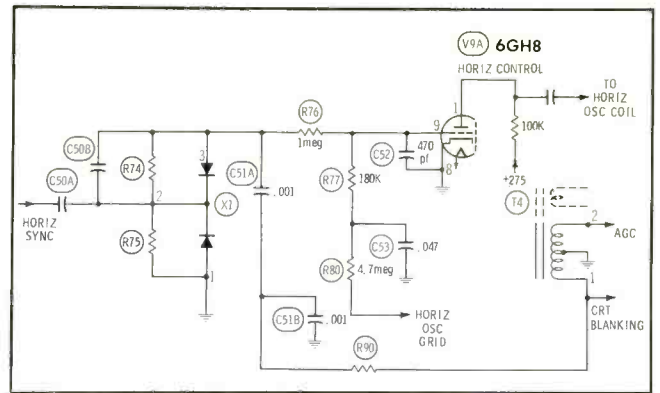

but with "pie crust". I would certainly appreciate your help.

Phillips B. Latta
Durham, N.C.

Something is very wrong with the phase of the sawtooth that is applied to terminal 3 of X1, the duo-diode. Since you have checked or replaced C51A, C51B and R90, this leaves the winding of the high-voltage transformer, T4, as the primary suspect.

I saw a somewhat similar case once in which the reference pulse was taken from a secondary winding of a width coil. Someone had reversed the phase of the primary winding, and the picture locked with the blanking bar squarely in the center of the screen. It is probable that the winding of T4 might be open from terminal 1 to ground, or someone might have connected R90 to terminal 2. ▲

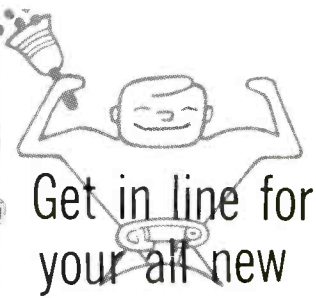

MIGHTY MITE VI

- Now faster than ever. Instant-on action with all solid state FET circuitry—no waiting for warm-up.
- New push-button operation speeds up every test—saves you valuable time.
- New 13th socket checks still more tubes—now over 3000 including foreign.
- New hi-style case—vinyl-clad and brushed steel. A professional instrument designed for professionals.

At your distributor now, only **\$99.50**



SENCORE

NO. 1 MANUFACTURER OF ELECTRONIC MAINTENANCE EQUIPMENT
426 SOUTH WESTGATE DRIVE, ADDISON, ILLINOIS 60101

Circle 21 on literature card

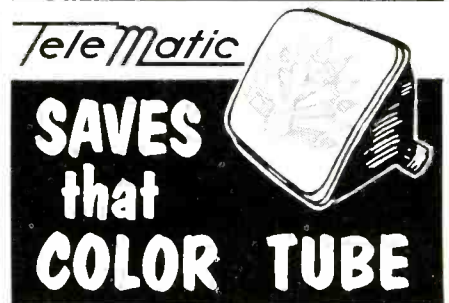

(WITH CATHODE HEATER SHORTS)

GET THE NEW
2-IN-1
ISOLATION
BRIGHTENERS

BOOST OR NO. BOOST, AT THE
FLIP OF A SWITCH.

MODEL CR-300 FOR 70° TUBES
MODEL CR-350 FOR 90° TUBES



Circle 22 on literature card

bookreview

How to Fix Transistor Radios & Printed Circuits: Leonard C. Lane, TAB Books, Blue Ridge Summit, Pa. 17214, TAB Book No. 504, 1969; 256 pages, 5½ inches X 8½ inches, hardbound, \$7.95; paperbound, \$4.95.

The purpose of this revised, second edition is to help the technician become acquainted with semiconductors and how they are used in home entertainment electronic equipment.

The first chapter deals with the fundamentals of semiconductors, while the second chapter discusses how transistors operate and introduces basic circuits. Chapter 3, titled "Basic Amplifiers", covers amplifier fundamentals, basic circuit configurations, biasing, FET's, JFET's and IGFET's.

The next two chapters are devoted to RF and IF stages and detectors, and AGC circuits, plus more advanced audio circuits, including output stages. Chapter 6 concentrates on auto radios, and Chapter 7 on FM radios.

Handbook of Practical Electronic Tests and Measurements: John D. Lenk, Prentice-Hall, Inc., Englewood Cliffs, N.J. 07632, 1969; 302 pages, 6 inches X 9 inches, hardbound, \$15.00.

Practical electronic test and measurement procedures encountered by electronic technicians are presented in this book. Each test procedure includes a detailed discussion of its purpose and the related step-by-step technique. Most procedures are described twice, once for use in "quick tests" using basic equipment, the other for laboratory work, employing more sophisticated gear.

The first two chapters cover voltage and current measurements. The next four chapters cover resistance, capacitance, inductance and impedance respectively.

Decibel measurements are

discussed in Chapter 7, while Chapter 8 deals with time, frequency and phase measurements. Chapters 9 and 10 are concerned with solid-state and microwave measurements. Chapter 11 covers antenna and transmission line measurements. The final chapter presents miscellaneous circuit and component tests. An index is provided for easy reference.

ABC's of Voltage-Dependent Resistors: Rufus P. Turner, Howard W. Sams & Co., Inc., Indianapolis, Ind. 46206, Catalog No. 20771, 1970; 96 pages, 5½ inches X 8½ inches, paperbound, \$2.95.

This book "explains voltage-dependent-resistor (VDR) theory in simple language, describes the many kinds of VDR's, and shows how they can be used in a variety of applications."

Basic VDR theory is covered in the first chapter. The remaining four chapters illustrate and discuss the various

applications of voltage-dependent resistors. An index is provided for quick reference.

101 TV Troubles — From Symptom to Repair: Art Margolis, TAB Books, Blue Ridge Summit, Pa. 17214, TAB Book No. 507, 1969; 224 pages, 5½ inches X 8½ inches, hardbound, \$7.95; paperbound, \$4.95.

This book is designed to be a reference that in minutes will lead the servicing technician to the cause of many troubles. Color and monochrome and solid-state and tube-type television sets are included, as well as simplified and partial schematics and other illustrations of the circuitry and layout of major brands of TV.

TV troubles are broken down into five basic categories: brightness, contrast, sweep, color and sound. Each category lists specific troubles relating to that symptom. An index also is provided. ▲

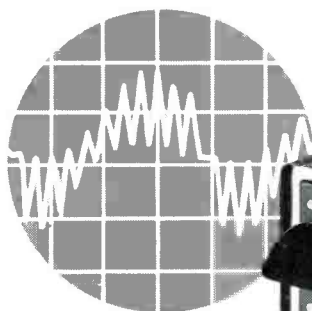

Standard RCA
"S" Curve



Vector
Pattern

DOUBLE

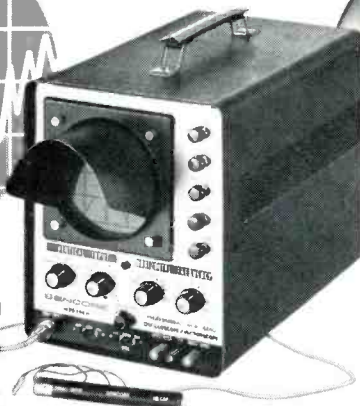

FEATURE

PS148A OSCILLOSCOPE • VECTORSCOPE

With NEW "Triggered Action" sync.

Guaranteed to lock in composite video waveforms faster than a triggered scope or your money returned.

- High sensitivity wide band oscilloscope.
- Professional 5-inch vectorscope. Converts at the flick of a switch in the rear.
- Equips you for every servicing job—complete for color servicing.
- Outstanding flexibility—ideal for field engineering and production line testing.

A Sencore Top Performer, only \$269.50 All Domestic Made

IN STOCK AT YOUR LOCAL
PARTS DISTRIBUTOR.



SENCORE

NO. 1 MANUFACTURER OF ELECTRONIC MAINTENANCE EQUIPMENT
3200 Sencore Drive, Sioux Falls, South Dakota 57100

Circle 23 on literature card

Isolating distortion in stereo systems

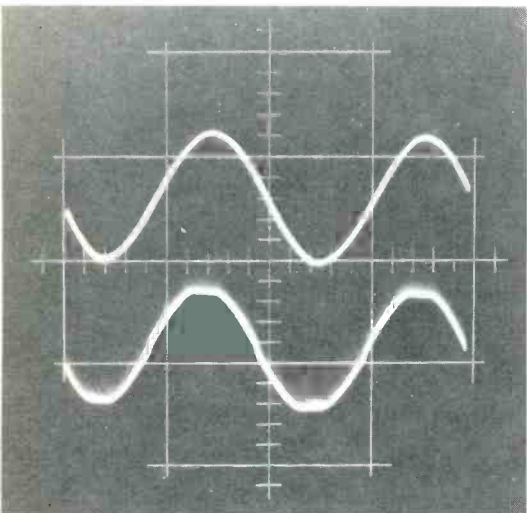

Fig. 1 Dual-trace oscilloscope photo showing undistorted input signal (upper trace) and distorted output signal (lower trace).

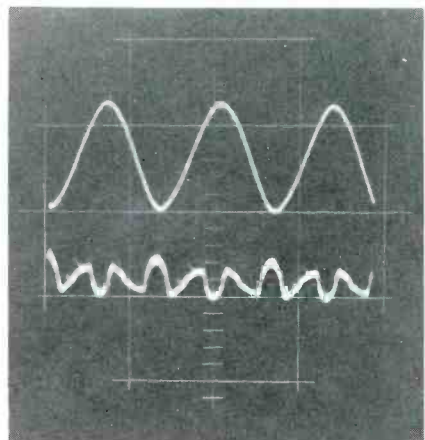

Fig. 2 Distortion analyzer enables the user to analyze the content of distortion. Upper trace is "clean" input; lower trace is amplified representation of harmonic distortion content in output of amplifier whose output waveform is shown in Fig. 1.

Common causes of and time-saving techniques for finding harmonic, intermodulation, crossover, amplitude and other forms of distortion.

by Leonard Feldman

Harmonic Distortion

The most familiar and common type of distortion in audio systems is harmonic distortion (HD), which is characterized by the undesired presence of frequencies or tones which are an arithmetic multiple of the desired tone or tones. For example, a pure 1000-Hz tone fed into an audio amplifier might produce in the output varying amounts of 2000-Hz, 3000-Hz, 4000-Hz signals, etc. These harmonics change the audible sound produced by the amplifier, and, if present in large amounts, they can change a pleasant sound into a very disturbing one.

It is this "harmonic content" that enables us to distinguish the sound of one musical instrument from another. Middle A on a piano keyboard has exactly the same fundamental frequency as middle A played on a violin, yet we can easily distinguish between the two instruments, primarily because of the percentages of harmonics, or multiples, of the fundamental frequency.

In musical instruments, these harmonics are necessary and desirable. This is not the case in audio equipment. We like to get out of them **only** what we put in—which means

that the amplifier should not generate tones of its own.

Fig. 1 is a photo of a scope on the screen of which a double trace has been achieved by means of an electronic switch. The upper trace is a "clean" 1000-Hz input tone fed to an amplifier. The lower trace is the actual output waveform of the amplifier. The "clipped" tops and bottoms of the sine wave represent severe distortion, which would be very apparent to most listeners.

To measure the actual percentage of distortion, the output signal is fed to a distortion analyzer. The distortion analyzer "nulls out" the fundamental, or desired, frequency, leaving only the undesired harmonics, whose amplitudes are measured directly as a percentage of the amplitude of the desired signal. To display the "distortion" on a scope, amplifying circuitry is included in the distortion analyzer.

The display shown in Fig. 2 shows the clean input signal (upper trace) and the distortion product (lower trace). By counting the number of sinusoidal waveforms in the distortion product in Fig. 2, it can be determined that it consists primarily of "second harmonic" frequency, though traces of higher harmonics are present as well.

Experienced listeners can detect harmonic distortion percentage as low as 1%, while less acute listeners can tolerate distortion percentages as high as 5% without noticing them.

The prices of distortion analyzers range from under \$100.00 in kit form to about \$650.00 for professional laboratory models. This instrument really is indispensable for

anyone who services a large amount of high-fidelity stereo component equipment.

Intermodulation Distortion

Another common form of audible distortion which occurs in consumer audio equipment is called intermodulation distortion (IM). Like harmonic distortion, it usually results when an amplifier is driven beyond its power-handling capability. Most experts feel that intermodulation distortion in significant amounts is even more objectionable than harmonic distortion. While harmonic distortion generates undesired frequencies that are directly related mathematically to the fundamental, intermodulation distortion produces totally unrelated frequencies. Certain non-linearities in the amplifier circuitry can actually produce "beat" frequencies in much the same way that a superheterodyne radio receiver produces sum and difference frequencies of the incoming RF signal and the local oscillator. For example, suppose a given instant of musical programming contains a 60-Hz bass tone and a 7000-Hz treble tone. In this case, frequencies of 7060 Hz and 6940 Hz represent the intermodulation distortion products of the amplifier.

This form of distortion also is measured as a percentage of the amplitude of the desired total composite signal and, again, percentages of from 1% to 5% or more can be extremely annoying.

Fig. 3 shows input and output waveforms used in the measurement of intermodulation distortion. The low-frequency component applied is four times the amplitude of the high frequency—a standard agreed upon by the industry. An intermodulation distortion analyzer measures the "beat frequencies" produced by the non-linear overload shown in the lower trace of Fig. 3, and expresses the result in percentage on a meter.

Vacuum tube amplifier designs almost always produce IM distortion that is about four times as great as the harmonic distortion. In solid-

state designs, this relationship does not hold true; IM figures generally run about the same or a bit higher than harmonic distortion.

Power output used to be the primary factor related to both harmonic distortion and intermodulation distortion. However, in these days of solid-state amplifier designs that use class B operation, distortion at low power-output levels has become quite prevalent. It is not uncommon to encounter a distortion-versus-power-output curve similar to that shown in Fig. 4, in which the harmonic and/or intermodulation distortion increases not only as maximum power output is approached, but at extremely low power levels as well.

Crossover Distortion

Fig. 5 is a schematic of a simple, low-powered phonograph amplifier using a complementary-symmetry output (push-pull circuit with NPN and PNP transistors fed by a common input). Forward bias for both output transistors is created by the voltage drop between the DC supply and R3 and D1 and R4, and is

intended to insure full half-cycle conduction of each of the output devices. If the forward bias is set incorrectly, or changes because of low ambient temperatures or because of a change in supply voltage, etc., each output device will conduct for less than a complete half-cycle, pro-

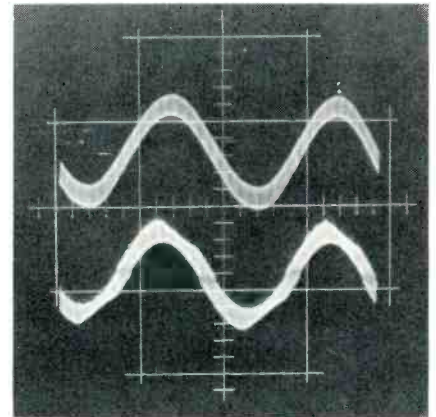

Fig. 3 IM distortion is caused by the non-linear amplification of two widely differing frequencies, which produces sum and difference frequencies. Upper trace is undistorted input. Lower trace is "clipped" output.

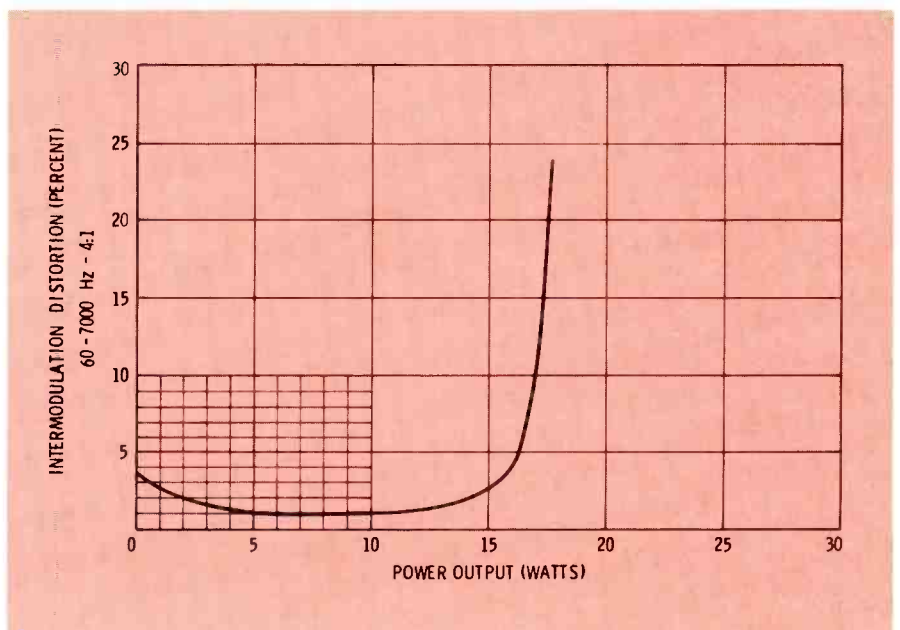

Fig. 4 In some amplifiers, distortion increases with lower power outputs as well as at overload. This conditions usually is caused by "crossover distortion".

ducing an output waveform like that in Fig. 6.

Twice per cycle a brief period exists during which neither output transistor conducts linearly, and crossover distortion is generated. Since the duration of the non-conduction period is constant, it will constitute a greater percentage of distortion at **lower** output levels than it will at higher output levels, and it is for that reason that the overall distortion percentage actually increases as output power is decreased. This form of distortion is particularly objectionable because the harmonic content contributes a "buzzing", almost crackling, effect to the program material.

Amplitude Distortion

Amplitude distortion usually is called "poor frequency response", but in fact it is really as much a

form of distortion as the other types already discussed. For example, if the gain of an amplifier is 6 dB higher at 8 KHz than it is at 4 KHz, musical balance will be thrown off if all other elements of the system are flat. Furthermore, if a 4-KHz musical note is being amplified, and if the amplifier contributes 2% of second harmonic distortion (undesired 8-KHz signal), this actually will produce 4% distortion because of the extra treble boost in the amplifier. If this suggests that tone controls should be "banned" from all amplifiers, there is some justification to the premise. Tone controls really should be used only to compensate for other peaks or deficiencies in the response of a system. Unfortunately, most consumers misuse these controls, turning up bass and treble controls to "show off" their systems.

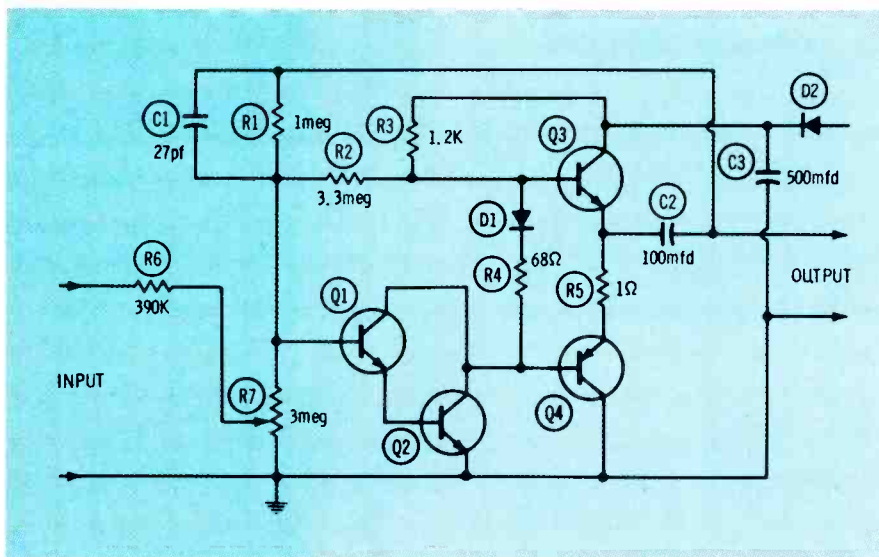

Fig. 5 A typical "complementary symmetry", push-pull amplifier in which forward biasing on output devices must be critically adjusted.

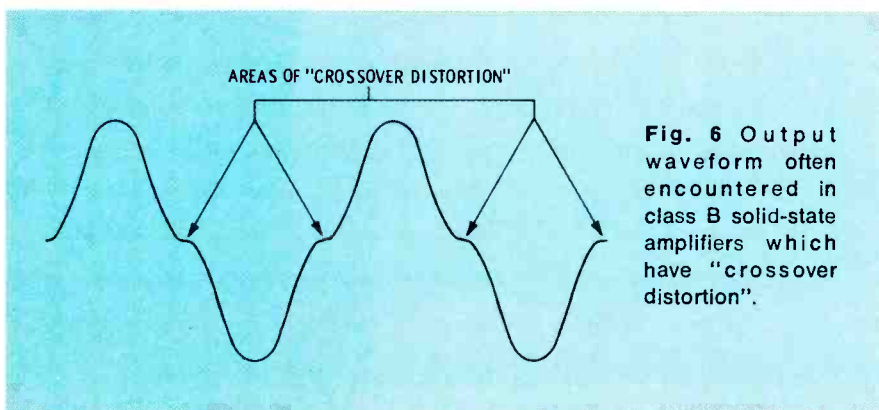

Fig. 6 Output waveform often encountered in class B solid-state amplifiers which have "crossover distortion".

Environmental Distortion

Into this last category of distortion are lumped such miscellaneous conditions as room acoustics, mechanical buzzes caused by "sympathetic" vibration of objects located adjacent to loudspeaker systems, and room resonances which emphasize certain low frequencies out of proportion to others.

Although these conditions are usually relegated to the domain of the professional acoustic engineer, service technicians often can isolate and correct troubles related to these conditions, if they are familiar with them. The addition of draperies or carpeting often can correct an overly shrill-sounding listening environment. Moving stereo speakers to a new location often can "balance", or cancel out, specific low-frequency room resonances. It takes a bit of experimenting and a lot of patience, but it is worth the effort in terms of the customer's satisfaction.

Incorrect Input Levels

The great flexibility of component stereo high fidelity has long been recognized, but it is this same flexibility which often causes high orders of distortion which really are not the fault of any single component in the system.

Fig. 7 is a block diagram of a typical system, consisting of a tuner, a preamplifier, an amplifier and a phono and tape system. The chart indicates minimum and maximum input and output levels for each device. If the system is set up with the actual operating levels shown in Fig. 7, several components will be misused or adjusted to incorrect levels with respect to the mating components. Note that the input stages of the power amplifier will be overloaded rather than the output stages. Under these conditions, there will be audible distortion, even with the amplifier master-volume control turned down to "whisper" levels.

It is of great benefit to have level and volume controls on every component in a system, but it also can lead to severe mismatching of levels if instructions are not followed.

Incorrect Output Stages

Because today's high-fidelity amplifiers are designed to provide fair-

ly high power levels, it is not practical to check maximum power output using loudspeakers, because the sound would be deafening if steady-state single tones were used.

Most high-power wirewound resistors normally used as dummy loads contain a fair amount of inductance, which can upset the output characteristics of some amplifiers, and also lead to erroneous readings.

The best and easiest dummy load to use as a speaker substitute is one consisting of a number of 2-watt carbon composition resistors, arranged in parallel so that their net value equals 8 ohms (the most common high-fidelity loudspeaker impedance). For example, we built two such resistive loads using twenty-eight 220-ohm, 2-watt resistors in parallel for each load. Besides the non-inductive advantages of such an arrangement, this gave us a pair of

loads each capable of absorbing 56 watts of audio power **continuously**—suitable for even the highest powered amplifiers.

Two setups for observing output waveforms are shown in Figs. 8A and 8B. In Fig. 8A, observation of the output waveform is made directly by an oscilloscope, and distortion amounts are estimated from experience, in the absence of a distortion analyzer. In Fig. 8B, a distortion analyzer is interposed between the output and the scope, so that distortion content can be observed on the scope as well as measured on a meter. Usually, better amplifiers will have a bias adjustment potentiometer somewhere in the circuit, and if instructions do not detail optimum quiescent output stage current, the best means of adjustment is observation of the scope for lowest distortion as the bias control is rotated from one extreme to the other.

Program Source Distortion

Besides discrepancies in matching levels between components, distortion often is produced by one or more of the program source elements of a stereo high-fidelity system, such as the FM tuner, the pickup cartridge of the phono system or a tape deck or transport mechanism.

Because many signal sources usually are connected to a system, the first thing to do is eliminate the amplifier as suspect by listening carefully to each of the system's program sources. If distortion occurs with only one of the sources (say, the FM tuner), make sure the output level from this component is compatible with the input-level requirements of the amplifier or preamplifier to which the signal is being fed. If levels seem right, observe the output of the offending system component on a scope, preferably feeding a single mid-frequency tone to the suspect component. In the case of phono or tape, this will mean using a frequency test record or tape. In the case of FM, some form of FM signal generator with built-in modulating frequencies will be required.

Distortion analyzers can be used with "voltage output" components as well as with power amplifiers. Usually, only 0.1 or 0.3 volt is required to calibrate most distortion analyzers to 100% reference points on the meters.

If distortion is noted in the output of an FM tuner, it usually can be traced to poor alignment of the tuner, mistuning or, in rare instances, to the single audio amplification stage often employed just ahead of the tuner output.

Distortion found in phono or tape systems requires a bit more analysis, because these devices include transducers, such as tape heads, phono cartridges, etc., as well as preamplifier stages associated with them. Waveforms should be examined first at the preamplifier outputs of these system components, ahead of the main amplifier. If distortion is noted, a low-level audio signal should be fed to the input of the preamplifier involved. Audio levels for tape head preamplifier inputs are usually no more than 1 millivolt, while for most magnetic cartridges the level varies from under 1

Operating Levels for System in Fig. 7

Component	Input Min.	Input Max.	Output Min.	Output Max.
Tuner	—	—	0 (has volume control)	2 volts rms
Phono Cartridge	—	—	—	0.1 volt rms
Tape Unit	—	—	0.1 volt (has control)	0.5 volt
Preamp: Tuner input	0.1 volt	0.5 volt	0.5 volt	2.5 volts
Phono input	2.0 mv	70 mv	0.5 volt	5.0 volts
Tape input	0.1 volt	0.25 volt	0.5 volt	2.5 volts
Power Amplifier	0.25 volt	0.5 volt	—	50 watts

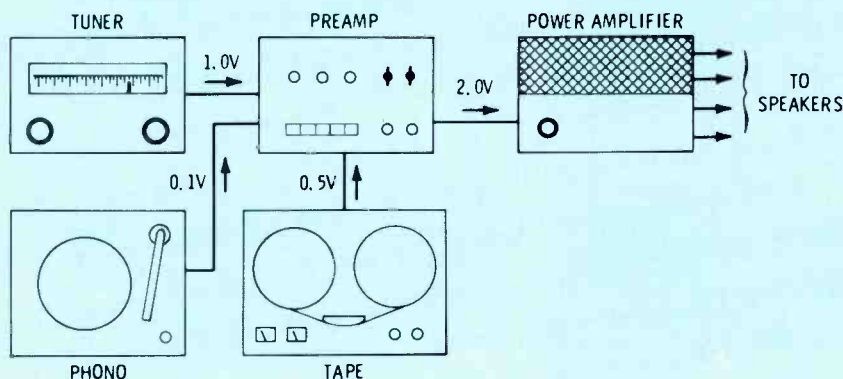
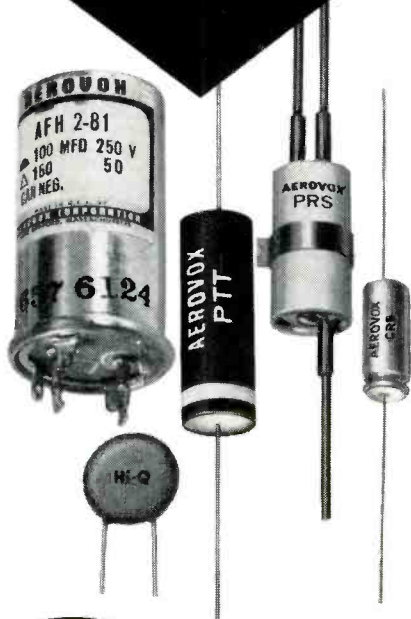

Fig. 7 Typical hi-fi component setup. Accompanying table shows that levels of input to preamplifier and amplifier are misadjusted, causing distortion in first three stages of preamplifier and amplifier.

Use Aerovox capacitors available from your local AEROVOX DISTRIBUTOR

He's your best "one-stop" source for virtually every replacement capacitor you require. He carries the complete Aerovox line which includes: ceramics, micas, electrolytics, papers, film and interference filters. So no matter what your replacement requirement, you're sure to find it at an Aerovox Distributor.

service it
FAST
with
components
that
LAST!



AEROVOX
Hi-Q
AEROVOX
CORPORATION

DISTRIBUTOR SALES, New Bedford, Mass. 02741

Circle 24 on literature card

50 ELECTRONIC SERVICING/June, 1970

millivolt to about 5 millivolts, at mid frequencies.

If the preamplifier section is distortion-free, the transducer itself should be suspected. In the case of phono cartridges, this can mean a defective stylus which is unable to track the record groove and generates distortion, a mechanically defective coupling between stylus and the rest of the cartridge structure or, in the case of ceramic or crystal cartridges, a defective element.

Don't overlook the fact that the records being played also might be worn, contributing significant amounts of audible distortion. This effect will be first noticed with respect to high frequencies, since these closely spaced undulations in the record groove wall are worn or distorted more easily than low-frequency recorded information. In the case of tape heads, loss of good frequency response, especially high frequencies, means misalignment of the head with respect to the tape travel, or, more often, dirty heads coated with oxide compounds, which are picked up from the tape. Other than these purely mechanical defects, there is little that can go wrong with a tape head, short of an open coil, which would be obvious.

Speaker System Distortion

It is often stated that loudspeaker systems "never wear out". Noth-

ing could be further from the truth. A loudspeaker is called upon to move air by means of a vibrating cone, and anything that vibrates continuously in this manner, and must be suspended and centered with extreme accuracy, is certainly subject to wear.

Often, a rubbing voice coil or a stiff, restricted cone of a loudspeaker can sound very much like a distorted amplifier. The only way to tell the difference is by isolating the two elements by means of waveform analysis.

If you hear distortion in a system, and have eliminated the signal sources as the cause, the next thing to do is to connect your scope at the input terminals of the speaker itself. If the waveform observed there (either by listening to program material or by means of a test tone fed to the amplifier) is still "clean", you can be relatively certain the distortion is originating in the loudspeaker itself.

In a multi-speaker system containing woofer, mid-range and tweeter, placing your ear close to these individual speakers usually will disclose which is defective. Most service shops are not properly equipped to repair speakers which are mechanically defective; this work should be left to the manufacturer of the particular speaker, if possible. ▲

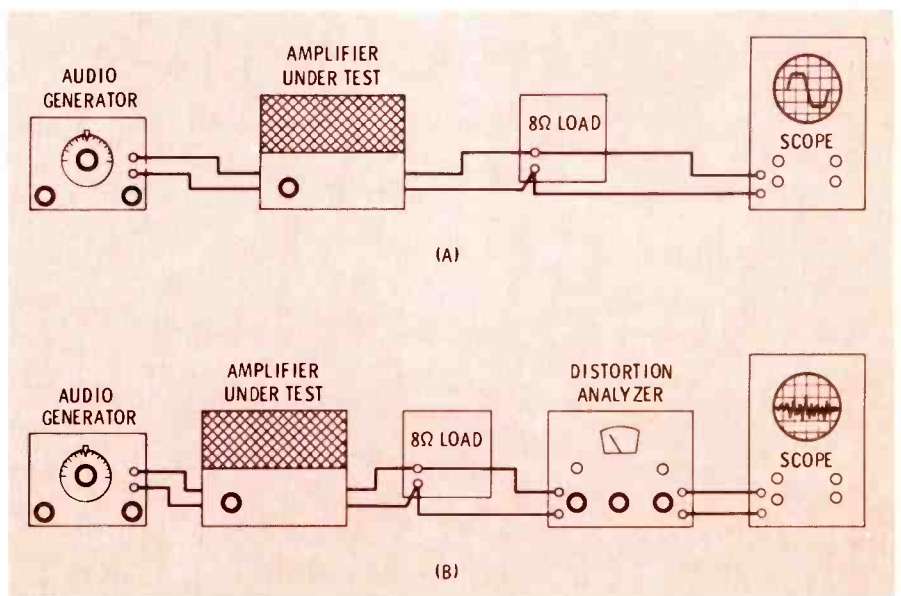

Fig. 8 Two methods used to examine amplifier distortion using: (Top) an oscilloscope connected across dummy output load, and (Bottom) using a distortion analyzer to feed the scope with just the distortion content.

NEA Annual Convention Agenda

The annual convention of the National Electronic Associations (NEA) will be held July 14-19 at Stouffers River Front Inn, St. Louis, Missouri.

A complete schedule of both business and family recreational events has been planned.

Those planning to attend should register for the convention and make their own hotel reservations as soon as possible; those arriving late who have not registered in advance can do so between 9:00 AM and 6:00 PM the first two days of the convention and between 9:00 AM and 12 noon the remaining days.

Business Agenda

Tuesday, July 14

9:00 AM to 6:00 PM—Registration open

Wednesday, July 15

9:00 AM to 6:00 PM—Registration open

9:00 AM to 4:00 PM—Business Management School (two-day course)

Supervised by: Miles Sterling, California State Electronic Association

Cost (including 4 coffee breaks and two luncheons):

NEA members \$30.00

nonmembers \$40.00

Place: Daniel Boone Room

Thursday, July 16

9:00 AM to 6:00 PM—Registration open

9:00 AM to 4:00 PM—Business Management School (2nd and final day)

9:00 AM to 4:00 PM—Alignment School (one-day course)

Produced by: Test Equipment and TV Manufacturers

Cost (including 2 coffee breaks and luncheon):

NEA members \$10.00

nonmembers \$14.50

Place: Spirit of St. Louis Room

5:00 PM to 6:00 PM—NEA Board Meeting (NEA officers and state presidents)

Friday, July 17

8:00 AM—Breakfast sponsored by TSA of Iowa

Speaker: Robert Elder, Radiological Health Center
Cost: No charge to registered guests

9:00 AM to 12 noon—Registration open

9:00 AM to 12 noon—NEA business meetings

Place: Lewis & Clark Room

9:00 AM to 4:00 PM—Alignment School (repeat of course offered on Thursday)

11:00 AM—Speech by Gordon Burns (place and theme of talk not announced)

12 noon—Nebraska Electronic Service Association
Speaker: Keynote address by Rodger Brehm, CET, NESA.

Cost: No charge to registered guests

4:00 PM—Speech by George Mena, Centralab, Member Service/Dealer Committee of EIA Distributor Products Division

Subject: Cooperation between elements of electronic industry

6:30 PM—Hall-of-Fame Banquet and presentation of membership awards by M. L. Finneburgh, Sr., Chairman of the Board, The Finney Co.

Cost: No charge to registered guests

Saturday, July 18

8:00 AM—Indiana Electronic Service Association (IESA) Breakfast

Cost: No charge to registered guests

9:00 AM to 12 noon—Registration open

9:00 AM to 12 noon—NEA business meetings

Place: Lewis and Clark Room

9:00 AM to 4:00 PM—Alignment School (repeat of one-day courses conducted on Thursday and Friday)

12 noon—Luncheon

Cost: No charge to registered guests

4:00 PM—Talk by Guillermo L. Russell, CET, President of Television Service Association of Delaware Valley (Philadelphia)

Subject: "From 34 to 215 members in our association locally . . . the many advantages."

6:30 PM—Cocktail Party, sponsored by Howard W. Sams & Co., Inc., Indianapolis (Publishers of PHOTOFACT's and ELECTRONIC SERVICING magazine)

Cost: No charge to registered guests

7:30 PM—Presidents Dinner Dance, sponsored by California State Electronic Association—Surprise entertainment

Cost: No charge to registered guests

Sunday, July 19

9:30 AM to 11:30 AM—Brunch

Cost: No charge to registered guests

10:00 AM to 2:00 PM—NEA business meeting

Place: Lewis and Clark Room

2:00 PM—NEA Board of Directors Meeting (new officers and state association presidents)

Registration For Pre-Paid "Guests" Events

The following prices include 3 breakfasts, 3 luncheons, 1 brunch, 1 banquet, 1 dinner-dance, 1 riverboat trip and 1 cocktail party.

	Members	Nonmembers
Men	\$42.50	\$50.00
Ladies	37.50	42.00
Young Adults (12 to 18 years)	32.50	37.50
Children (Under 12)	24.50	30.00

Family Recreation Activities

Recreation activities begin at 1:00 PM Tuesday with a bus sight-seeing tour of St. Louis and conclude Saturday with a Teen Dance at 7:30 PM. Between these two events are packed a wide variety of other pre-paid and pay-as-you-go family recreational events including swimming, tennis, shuffle board, opera, golf tournament, bowling tournament, trips to zoo, animal shows, boat trip, etc. ▲

PHOTOFACT BULLETIN lists new PHOTOFACT coverage issued during the past three months for new TV chassis. This is another way ELECTRONIC SERVICING brings you the very latest facts you need to keep fully informed between regular issues of PHOTOFACT Index Supplements issued in March, June and September. PHOTOFACT folders are available through your local parts distributor.

AMC

3C-432A, 3C-436A,
3C-438A1090-1
3C-410A1095-1

ADMIRAL

Chassis T3K4-1A/-1B1093-1
9P400 (Ch. NA1-1A)1098-1

BRADFORD

1105C30, 1105F30,
WTG-56325A,
WTG-60053A1093-2

CATALINA

122-240A, 122-244A,
122-248A1095-2

CORONADO

TV2-6626A, TV2-6627A ...1098-2
TV2-6633A1100-1

CHANNEL MASTER

6108A, 6112A, 6116A1093-3

CROWN

7TV-1, 7TV-21090-2

EMERSON

12P60A/B, 12P61W1096-1
29P101098-3

GENERAL ELECTRIC

Chassis H-31094-1
Chassis C-11100-2

HITACHI

TWU-651091-1
IA-511092-1
TWU-60, TWU-661096-2

MAGNAVOX

Chassis T945-01-AA1099-1

MOTOROLA

Chassis C12TS-4651091-2
Chassis TS-921 Series
(Codes C-00 thru D-03) ...1096-3

OLYMPIC

CT400 (Ch. CT1990)1099-2

PACKARD BELL

CQ-6221092-2

PENNCREST

4851B-48, 4852B-46,
4853B-491099-3
2318, 2324, 2328, 23311100-3

RCA

Chassis CTC38AB/XA/XAH/
XB/XC/XF/XJ/XK/XL ...1092-3
Remote Control Receiver
CTP11H,
Transmitter CRK9C1092-3-A
Remote Control Receiver
CTP12F,
Transmitter CRK10C1092-3-B

SEARS

Chassis 562.104311090-3
5037 (Ch. 564.80120/121) 1097-1

SEARS SILVERTONE

Chassis 528/529.72660
thru 528/529.726881091-3

SYLVANIA

Chassis B-12-1, B12-21094-2

TRIUMPH

RK-56011094-3

WARDS AIRLINE

GEN-11960A (63-11960) ..1097-2

ZENITH

A2410C2 (Ch. 14N22)1095-3
Chassis 14A9C50, 14A9C51 1097-3
Remote Control Receiver
S-77536,
Transmitter S835961097-3A
AM-FM-FM Stereo
Chassis 20AT30/Z1097-3B

AMC	3C-420B	1104-1
CATALINA	122-738B	1101-1
	122-740A	1105-1
CHANNEL MASTER	6105, 6109A, 6113A, 6117A	1101-2
DUMONT	59T01W, 59T02W (Ch. 120916A, 120972)	1102-1
	(Remote Control Receiver 471965 and Transmitter 471937 included with TV)	
EMERSON	Chassis 120924A/B	1104-2
HITACHI	CFA-550	1103-1
MIDLAND	15-009	1105-2
MUNTZ	2180	1104-3
PANASONIC	CT-23P, CT-23PC, CT-24W	1102-2
PENNCREST	685-4827, 2631-48A	1106-2
PHILCO-FORD	B610TWH, B630TWA (Ch. 20R27)	1102-3
REALISTIC	16-1251, 16-1252	1106-1
RCA	EP404W (Ch. CTC22AD) .	1107-1
SEARS	5019 (Ch. 562.10890)	1101-3
	5004 (Ch. 564.80100, 564.80102)	1103-2
	4074 (Ch. 562.10481/482/ 520/521/522/523/ 524	1107-2
SYMPHONIC	TPT-126	1107-3
WARDS AIRLINE	GHJ-17220A, GHJ-17240A, GHJ-17250A	1103-3
ZENITH	A3914W2(FC)	1105-3
	Remote Control Receiver S-80373, Transmitter S-68933	1105-3A
	Z6549H09 (Ch. 14Z8C50)	1106-3
	Remote Control Receiver S-77536, Transmitter S-68936	1106-3A



**"Can't you say anything besides,
Goodness, Gracious, Mercy?"**

FREE CATALOG

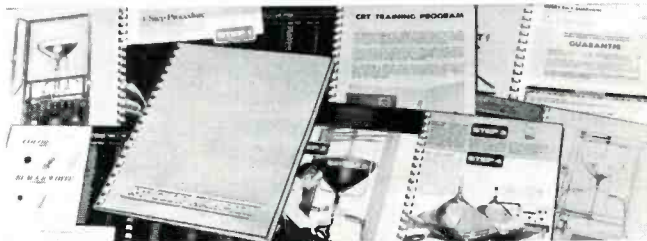

CRTOLOR CHAMPION

TV PICTURE TUBE REBUILDING EQUIPMENT

C.R.T. Equipment Company, Inc.
2740 Old Lebanon Road
Nashville, Tennessee 37214

Telephone (615) 883-0215

Mail Coupon Today

(Please Print)

Name _____

Firm Name _____

Address _____

City _____ State _____ Zip _____

Clip Me Out

Circle 25 on literature card

MOBILE RADIO SERVICING / Part 1

An introduction

First of a three-part series that will familiarize you with this profitable field, including troubleshooting techniques and proof-of-performance tests.

by Leo G. Sands

The Business Is There To Get

Mobile radio has grown into a \$350-million per year business, as big as the entire electronics industry was shortly before World War II. By 1975, the volume of sales of mobile radio is expected to double. But, there are two hitches: 1) The FCC must allocate more channel space, and 2) more trained technicians must be available to service the equipment—otherwise the industry's growth rate will be stifled.

Most manufacturers have difficulty finding enough technicians to install and service their equipment. Motorola is one of the leaders in mobile radio sales because it has had a service organization, consisting of several hundred authorized independent service shops, for many years. GE and RCA, too, have many authorized independents. But, because independent servicers have not fulfilled the demand, Motorola, GE, RCA and Kaar have had to establish company-owned service centers.

How big is the servicing potential in mobile radio? Let's take the biggest first, to cite an example. It has been reported that there are in excess of 10,000 base stations and

more than 70,000 mobile units, not including Citizens-Band (CB) types, in the New York City metropolitan area. Yet, there are probably fewer than 50 full-time mobile radio service shops in the area.

A town like Marysville, Washington, probably has half a dozen base stations and around 50 mobile units.

Exclusive of CB, each mobile unit should produce about \$120 per year of service income (\$10 per month), including preventive maintenance and repair of equipment failures. Each base station should produce at least twice as much service income as a mobile unit.

Another potentially lucrative source of income is servicing of CB transceivers. Although these sets are simpler than commercial mobile equipment, most CBers (Citizens-band operators), unlike hams, have no technical skills and must look to a pro for service.

CB should produce substantial service income, but not on such a regular basis. There are around 4 million CB transceivers in use whose owners will have to spend an average of about \$20 per year for service. This means approximately \$80 million per year in service income.

There's plenty of room for newcomers in mobile radio servicing. It's not a matter of you looking for business—the business is looking for you.

Equipment Types

Even the most elaborate mobile radio unit or base station is a simple device compared to a TV set, even monochrome. Doubtful? Look at these block diagrams:

- Fig. 1—basic CB transceiver
- Fig. 2—sophisticated CB transceiver
- Fig. 3—basic FM mobile unit
- Fig. 4—repeater station.

Note that most of the blocks represent circuitry and functions which most hi-fi and TV technicians already are familiar. The exception is squelch circuits, which aren't that complicated—most consist merely of a DC amplifier and a DC-operated relay.

A mobile unit is a transceiver, or transmitter/receiver. So is a base station. A repeater is a transmitter/receiver plus control circuitry.

System Variations

Mobile radio systems differ slightly in design for various applications. Most employ single-frequency simplex, in which each station transmits and receives sequentially on the same frequency (Fig. 5). In a two-frequency simplex system, operation is sequential, but the base station and mobile units transmit on different frequencies, and can transmit and receive simultaneously, as in telephony. In a mobile relay system, which includes a repeater station, two frequencies are used on a simplex basis (Fig. 8).

While the preceding paragraph might make mobile radio sound complex, it actually isn't as complex as the simplest TV.

The same basic system concepts are used in police, fire, railroad, industrial, business and other commercial and public-safety radio systems. So-called class "D" CB systems employ either single-frequency simplex (Fig. 5) or two-frequency simplex (Fig. 6), in the 26.96- to 27.26-MHz band. Class "A" CB

TABLE 1 — MOBILE RADIO BANDS

MHz	Designation	Emission	Services
25-50	Low Band	FM, AM, SSB	All
26.96-27.26	Citizens Band	AM, SSB	Citizens
72-76	Mid Band	FM, AM	Manufacturers
150-174	High Band	FM, AM	All
450-470	UHF Band	FM, AM	All

stations also employ either one- or two-frequency simplex, but in the 460- to 470-MHz band.

Mobile Radio Bands

Table 1 lists the frequency bands in which land mobile radio systems may operate.

The low band (25-50 MHz) is used when maximum range is re-

quired, but is subject to more noise and skip interference from distant stations.

The high band (150-174 MHz) is the most popular band, and is ideal for the urban area communications.

Because the high band is getting so congested, the most promising band for the immediate future is the UHF band (450-470 MHz), in

which noise is seldom a problem and skip interference is virtually non-existent. Keep this in mind. If and when the FCC reallocates TV Channels 14, 15 and 16 for land mobile use, UHF band technology will be applicable.

What You Need to Know

To get into mobile radio servic-

TABLE 2
MOBILE RADIO TEST
EQUIPMENT MANUFACTURERS

	Frequency* Measuring	RF Wattmeters	Signal Generators	Modulation Meters (FM)	(Continued)	Frequency* Measuring	RF Wattmeters	Signal Generators	Modulation Meters (FM)
Beckman Instruments Inc. 2500 Harbor Blvd. Fullerton, Calif.	X				Measurements Division 42 Intervale Road Boonton, N. J.	X		X	X
Bird Electronics Corp. 30303 Aurora Road Cleveland, Ohio		X			Metric Engineering 5235 E. Simpson Road Mechanicsburg, Pa.			X	
Boonton Electronics Corp. Rt. 287, Smith Road Parsippany, N. J.		X	X		Mobil Electronics Inc. P. O. Box 1132 Anderson, Ind.		X		
Computer Measurements Co. 12970 Bradley San Fernando, Calif.	X				Motorola Communications & Electronics, Inc. Schaumburg, Ill.	X	X	X	X
Cushman Electronics Inc. 166 San Lazaro Ave. Sunnyvale, Calif.	X			X	PRD Electronics Inc. 1200 Prospect Westbury, N. Y.		X		
Eldorado Electrodata Corp. 601 Chaluma Road Concord, Calif.	X				Precision Apparatus Div. Dynascan Corp. 1801 W. Belle Pln. Chicago, Ill.			X	
General Microwave Corp. 155 Marine Farmingdale, N. Y.		X			RF Communications 1680 University Rochester, N. Y.	X		X	
General Radio Co. 300 Baker Ave. West Concord, Mass.	X		X		Radio Specialty Mfg. Co. 2023 S. E. 6th Avenue Portland, Ore.				X
Hewlett-Packard Co. Palo Alto, Calif.	X		X		Sierra Electronic Operation Meno Park, Calif.		X		
Hickok Electrical Inst. Co. 10514 DpPont Ave. Cleveland, Ohio			X		The Singer Company (Gertsch Department) 3211 S. La Cienega Blvd. Los Angeles, Calif.	X			
International Crystal Mfg. Co. 10 North Lee Ave. Oklahoma City, Okla.	X	X	X	X	Systron-Donner Corp. Concord, Calif.	X			
Lampkin Laboratories, Inc. Bradenton, Fla.	X			X	Telonic Instruments 60 N. 1st Avenue Beech Grove, Ind.			X	
Lavoie Laboratories Morganville, N. J.	X				Winslow Tele-Tronics, Inc. 1005 1st Avenue Asbury Park, N. J.			X	
The London Company 811 Sharon Drive Cleveland, Ohio			X						
Marconi Instruments 111 Cedar Lane Englewood, N. J.		X	X	X					

*Includes electronic counters

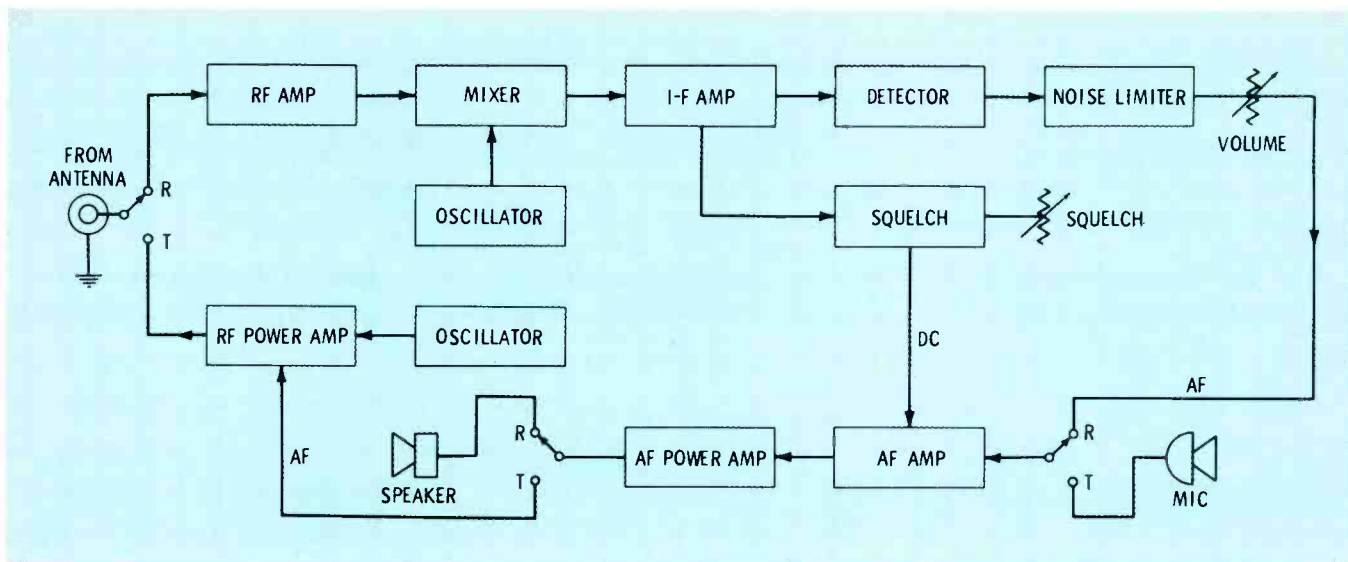

Fig. 1 Block diagram of a typical single-channel CB transceiver.

ing, you will have to know about the circuit operation and servicing of the following:

- AM and FM receivers
- AM and FM transmitters
- Squelch circuits
- Automotive electrical systems.

So, what's so difficult? Also, at least one man in the shop will have to possess a Second Class Radio Telephone Operator license. Any technician who is competent enough to service color TV, and who is willing to spend a few hours studying a Q and A manual, should be able to obtain this license.

Service and Installation Tasks

In the TV service business, you service and install electronic circuitry and antennas. You do essentially the same in the mobile radio business, except you have vehicles to contend with.

Installation

Installing an under-dash mobile unit is no more complex than installing auto stereo, except that an antenna is required. A trunk-mount system, on the other hand, includes a control head and multi-conductor cabling. In some cases, a selective calling decoder, teleprinter and/or voice scrambler also is installed.

Installation of mobile radio units has been simplified because it is no longer necessary to replace car generators with heavy duty car

alternators in modern cars usually are adequate, and the standby current drain of solid-state mobile units is very low, often only a fraction of an amp.

When remote control capability is not required, a base station can be simpler to install than a color TV. A base station transmitter/receiver can be a desk-top unit, or it can be contained within a wall-mount or floor-standing cabinet. The only electrical connections are to an AC outlet and to the antenna through coaxial cable. For remote control, a leased telephone line generally is used. When the remote control unit is in the same building as the base station, multi-conductor cable sometimes is used.

Since the "Carterfone Decision"* was made by the FCC, many mobile radio systems are being connected to the telephone system. The technician installs the phone patch, but the telephone company installs the protective block to which the patch system is connected.

Many base stations are installed on the roofs of tall buildings and on hilltops to obtain more favorable antenna elevation. A leased telephone circuit is required for linking such a base station to its remote control unit, except when a 960-MHz radio link or microwave system is used as the remote control transmission medium. A repeater station of a mobile relay system re-

quires no wire line since it is automatically controlled by its associated mobile units and control stations.

A base station can have more than one remote control unit and can be equipped with a selective calling encoder and/or speech scrambler. All except the high-power types (250 watts and up) operate from single-phase, 115-volt AC power.

Antenna towers, when they are required, and when they are more sturdy than the TV receiving antenna type, usually are erected by the tower manufacturer or a rigging contractor.

Preventive Maintenance

Preventive maintenance is a routine chore of the mobile radio technician. This usually consists of a monthly check and frequency measurement. When spare mobile units are available, a checked-out spare is usually installed and the original mobile unit is removed for a bench check. Preventive maintenance consists of visual and mechanical inspection, tube testing, alignment check and proof-of-performance tests.

Troubleshooting

Troubleshooting of mobile radio usually is simpler than TV servicing. Basically, all you have is an AM or FM receiver, a relatively simple transmitter and associated control circuitry. Tube-type units are easier to troubleshoot because

the parts are more accessible. Solid-state units, however, seldom are more difficult to troubleshoot than solid-state stereo receivers and amplifiers. Walkie-talkies are more difficult to troubleshoot because of their compactness.

Repairs mainly consist of replacing defective parts and cables. In many instances, it is necessary to use only exact replacement parts, instead of universal parts, in critical circuits.

Modifications

Another technician's chore is modification of older units as recommended by the manufacturer, and narrow banding of wide-band FM sets. This latter function usually consists of adding or replacing a selectivity filter and adjusting the FM deviation control.

Test Equipment

To service land mobile radio, in addition to scopes and the usual test equipment used for servicing TV, some special test instruments are required.

Perhaps the handiest testing device is a pen-type signal injector, which contains a multivibrator and enables quick check-out of nearly all RF, IF and AF circuits.

The most essential instrument is a frequency meter, accurate to at least 0.0001 percent. There are two basic types. One is continuously tunable and can be used for measuring all commonly used frequencies; however, it requires more skill to use them than the other type, which requires a crystal for every frequency to be measured. (A frequency meter also can be used as a signal generator or to check the frequency

of a conventional signal generator.)

A vital instrument is an RF wattmeter, for measuring transmitter output. These come in two basic types. One contains a 50-ohm dummy load. The other type is used with a plug-in dummy load and can be used for both measurement of transmitter output power and for tuning a transmitter to its antenna system.

The modulation capability of an AM transmitter also can be noted with an RF wattmeter. When modulated 100 percent by a sine-wave AF signal, power output increases 50 percent.

For checking FM transmitter modulation, an FM deviation meter is required. Some frequency meters can be used for this purpose.

A "home-radio" type RF signal generator is not good enough for aligning mobile radio receivers. A laboratory grade VHF/UHF FM signal generator is required. This is because it is necessary to be able to attenuate the RF output to a fraction of a microvolt. This cannot be accomplished with a lower-quality signal generator because there is too much RF leakage through the case. However, an expert can use such an instrument effectively. An AM signal generator can be used for aligning FM receivers, in spite of the popular belief that this is not true.

A sweep generator is valuable, although not popularly used by mobile radio technicians. It enables more accurate alignment of FM detectors, alignment of IF stages for proper bandpass, and observation of spurious responses.

Vitaly important is an accurate IF signal generator, preferably crystal controlled. A three-frequency signal generator equipped with 450-KHz, 455-KHz and 460-KHz crystals can be used for precise zeroing of an FM discriminator, checking IF amplifier and discriminator symmetry, and for setting the IF amplifier to exactly the right frequency. (This is very important in a crystal-controlled receiver). Such a signal generator also can be used for setting a tunable signal generator to exactly 455 KHz when the greater flexibility of a conventional signal generator is required. For IF alignment, a low-cost, home-radio type RF (AM) signal generator can be used if checked against a crystal-controlled calibrator, or when set to the midpoint of a selectivity filter's bandpass.

A good AF signal generator is required for measuring AF frequency response and tone squelch or selective calling components. Also, it is invaluable for troubleshooting receivers exhibiting AF distortion.

Service Manuals

Since the manufacturer's interests are served when its customers get good maintenance service, most will furnish service manuals to service shop operators. If a manufacturer refuses, the customer usually has a manual which customarily is furnished with the equipment. Schematics also can be obtained in circuit manuals made available by Howard W. Sams.

Crystals

It often will be necessary to re-

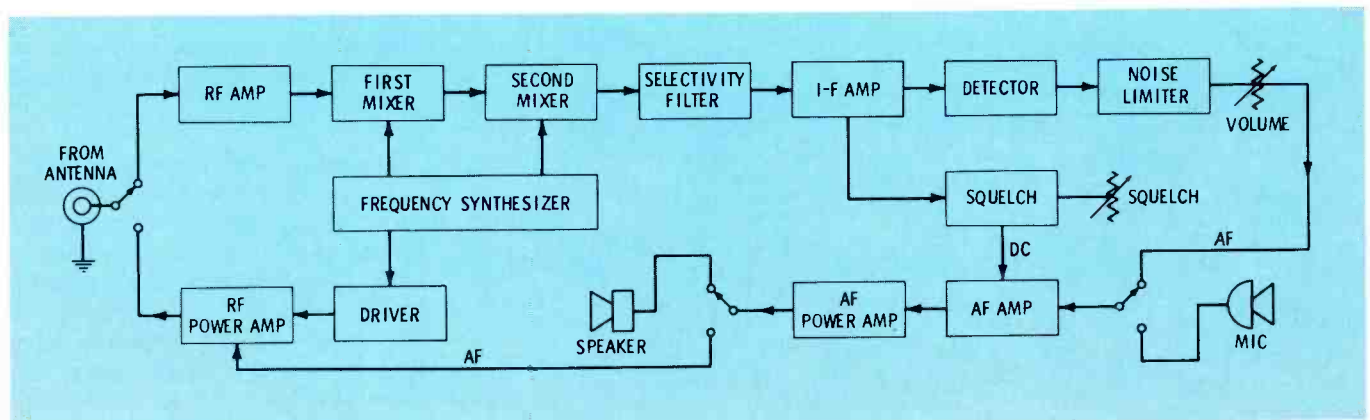

Fig. 2 Block diagram of a 23-channel CB transceiver.

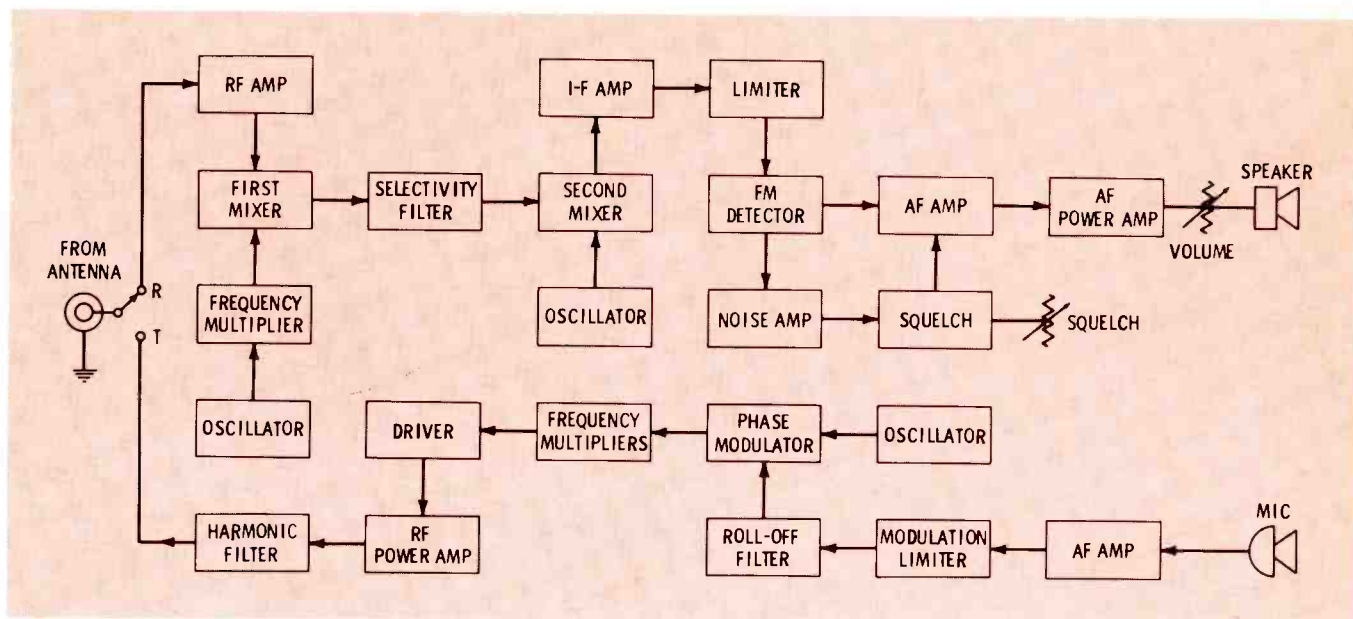

Fig. 3 Block diagram of an FM transmitter/receiver.

place crystals when the original ones are defective, and when changing channels. Crystals can be purchased from the radio equipment manufacturer or from numerous crystal manufacturers. (When ordering crystals, always indicate the crystal frequency and the make and model of the radio equipment. Because of variations in circuit inductance and capacitance which affects crystal frequency, the same crystal seldom can be used in two different models.)

FCC Rules

Every mobile radio shop should have copies of FCC Rules and Regulations, Parts 89, 91, 93 and 95, which can be purchased from the Government Printing Office, Washington, D.C. 20402. When FCC rules change, supplements are

mailed to purchasers of the rules. To keep up to date on FCC rules, it's a good idea to subscribe to the Federal Register (\$15 per year) through the Government Printing Office. This daily publication contains proposed rules changes and newly adopted rules, long before rules supplements are published.

Procuring Parts

Types and sources of replacement parts for mobile radio equipment are much the same as those for home entertainment electronic equipment. "Original equipment" parts are available from the manufacturer of the radio equipment, either directly or through a distributor. "Universal" replacement parts also can be used in some applications, and are available through

either an industrial electronics distributor or a radio-TV parts distributor. Although some radio-TV parts distributors do not handle "industrial" type parts, most will order them for you.

Buying Test Equipment

Most test equipment designed specifically for servicing communications equipment is not available at parts distributors and must be purchased directly from the manufacturer or through his representatives. Table 2 lists the names and addresses of some of the major manufacturers of special mobile radio test equipment from whom catalogs can be requested.

In lieu of having to invest a great deal of cash in test equipment, it can be leased or purchased on a time-payment basis. The manufacturer seldom handles leasing or financing. Your local bank can help you in this regard.

Manufacturer Appointments

To get started in mobile radio servicing, apply for "accreditation" by one or more mobile radio equipment manufacturers, such as Motorola, GE, RCA, Kaar, Pye, etc. The manufacturers generally want to know what kind of test equipment you have and if at least one technician has the appropriate FCC license. When you are accepted, the

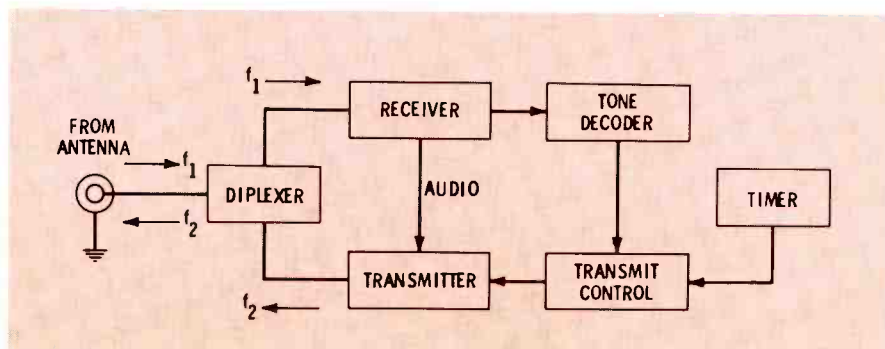

Fig. 4 Block diagram of an automatic mobile radio repeater station.

manufacturer will undoubtedly refer business to you.

Retailing

Many service shops also sell mobile radio equipment. It is not necessary to keep equipment in stock. When you make a sale, you order the equipment from the factory, equipped with crystals for your customer's channel.

CB sets usually are stocked, and crystals are installed by the dealer.

If you intend to sell mobile radio equipment, write to the Federal Communications Commission, Washington, D.C. 20554 and request a supply of Forms 400 and 505 for station license applications.

Setting Up the Shop

Adequate bench space should be provided so that several sets can be left turned on for warm-up while working on another. It isn't only tube warm-up we are concerned with. The entire unit should be at the temperature it achieves when in continuous use. Otherwise, frequency measurements could be misleading.

In addition to plenty of AC outlets, DC power is required for operation of mobile units. The power source for each set can be a 12-volt storage battery "floated" across a trickle charger. Better, however, is a metered, variable DC power supply whose output can be set to as high as 15 volts. A variable power supply enables simulation of voltage variations encountered in mobile installations.

Garage space should be available for vehicles in which radio equipment is to be installed or serviced. Obviously, extension cords and wire-cage protected lamps should be provided. The ceiling should be high enough to clear mobile radio antennas.

Test jigs will be required in the garage and at the benches to permit operation of equipment. When checking a trunk-mount unit in a car, for example, the control head, loudspeaker and microphone are out of reach. These components can be part of the test jig which is plugged into the mobile unit.

To prevent causing interference to others on the same channel, a supply of dummy antenna loads

should be available. Either an antenna or dummy load must be connected to a transmitter when it is operated. Otherwise, the transmitter can be damaged.

Monitor Receivers

In a small community with only half a dozen or so mobile radio systems, one of the new scanner-type receivers can be used for automatic monitoring of all local systems, if they all operate in the same band. One scanner-type receiver, for ex-

ample, can be equipped with crystals for up to eight channels. The receiver automatically scans all eight channels sequentially and locks in on a channel in use. When the signal ceases, the scanning resumes. By pushing buttons, any of the channels can be cut out or selected for continuous monitoring.

A monitor receiver also can be used as a test instrument for listening to modulation quality and for hum and noise. A mobile monitor receiver also is handy for making

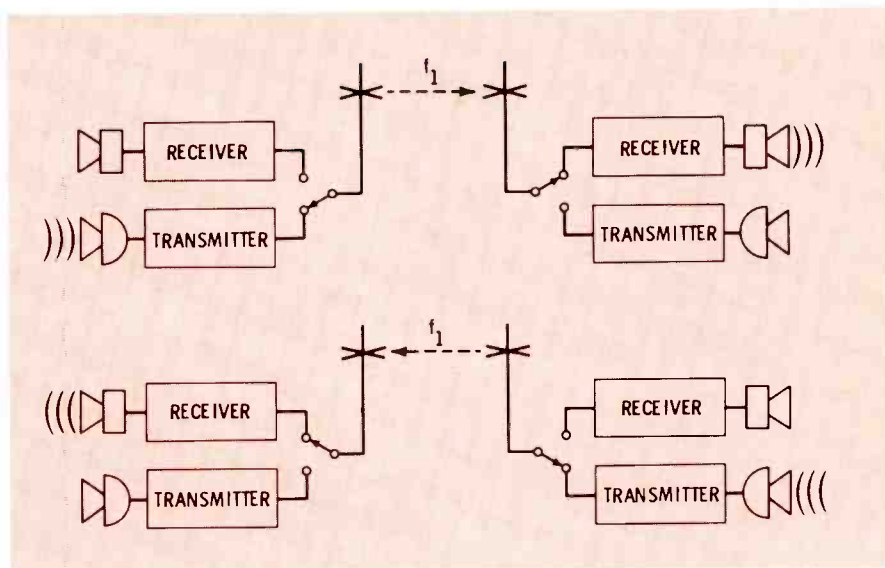

Fig. 5 Single-frequency simplex communication system. Each station transmits and receives sequentially on the same frequency.

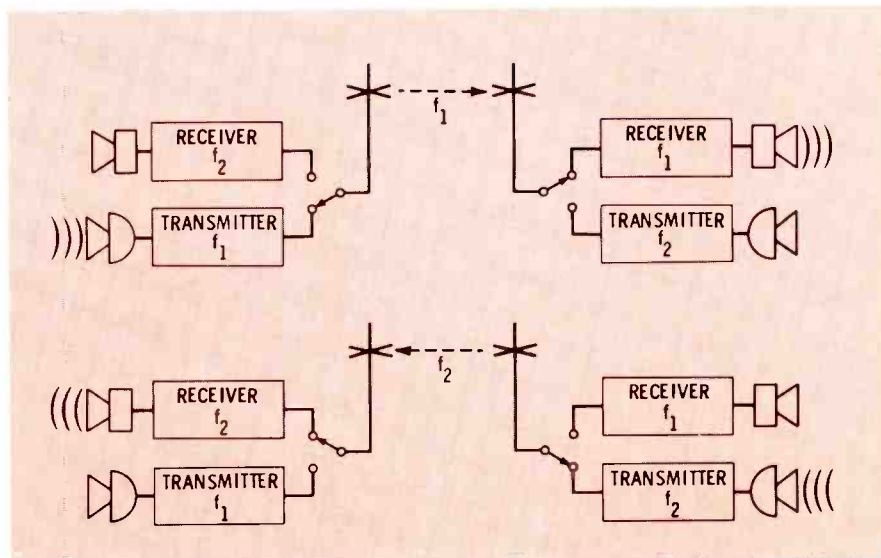
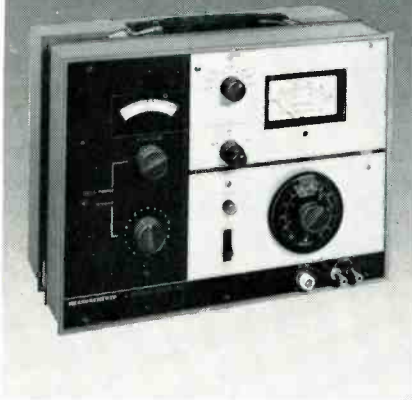

Fig. 6 Two-frequency simplex communication system. Operation is sequential, but base station and mobile units transmit on different frequencies.

MANUFACTURER'S STANDARD



MEASUREMENTS' MODEL 188 STANDARD FM SIGNAL GENERATOR ALSO MODEL 189 FM ALIGNMENT GENERATOR

Manufacturers of quality stereo and high-fidelity FM receivers have established the Model 188 as their standard for design and production. Why not service their receivers with the same equipment and obtain optimum performance?

FEATURES

- Range 86 to 110 MHz
- Accuracy $\pm 0.5\%$
- Output voltage .1 to 100,000 microvolts across 50 ohms
- Source impedance, 50 ohms
- Deviation, 0 to ± 300 kHz in 3 ranges
- Modulation, 400, 1000 and 10,000 Hz from internal audio oscillator
- FM distortion less than 0.5% at 75 kHz deviation
- Residual FM, 60 db below 75 kHz deviation
- Double shielding, negligible leakage
- May be used with existing multiplex modulators

The Model 189 meets all above specifications and, in addition, provides a 40-Hz, swept, 10.7 MHz signal with crystal markers for visual checking of i-f selectivity.

24

MEASUREMENTS

THOMAS A. EDISON INDUSTRIES

McGraw-Edison Co.
P. O. BOX 180
BOONTON, N. J. 07005
TEL: (201) 334-2131



Circle 26 on literature card

area coverage tests and for selecting base station and repeater sites.

Finding Customers

Your prospective customers won't know you service mobile radio equipment unless **you** let them know. Since they are relatively few, except CBers, advertising in newspapers and over a radio station may not be justified unless you also sell radio or "plug" radio-TV service too.

You can determine who some of your prospects are by looking for base station antennas. Also, your local police radio officer may know who uses two-way radio locally. Call books listing mobile radio system licensees are going to be published soon by R. E. Tall, National Press Building, Washington, D.C., whose firm also publishes daily listings of new license applications. Local lists of CB licensees may be purchased from **CB Magazine**, P.O. Box 60445, Oklahoma City, Oklahoma 73106.

Service Charges

Service charges should be estab-

lished by determining what it costs **you** to produce a given unit or time span of service, and then adding to that figure the percentage of profit the local market will allow. You can furnish service on both a time basis and on a monthly contract basis. Typically, the charge is about \$10 per hour of service or fraction thereof during normal business hours. Emergency service at other hours can command from \$20 to \$25 per hour or service call.

On a monthly contract basis, the fee typically is about \$12.50 per mobile unit, plus \$25 to \$50 for the base station. This entitles the customer to drive his mobile radio-equipped vehicles to your shop for preventive maintenance or repair during regular business hours. The base station is checked out once a month, and emergency repair service is provided at any time on two-hours notice.

Typically, service shops charge from \$15 to \$40 for installing a mobile unit, depending on the complexity of the system. Ignition noise suppression is not included in the basic charge.

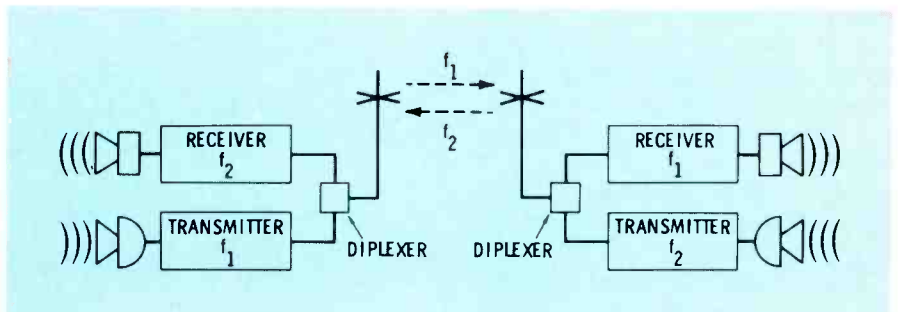

Fig. 7 Two-frequency duplex communication system. Base station and mobile units transmit on different frequencies, and can transmit and receive simultaneously.

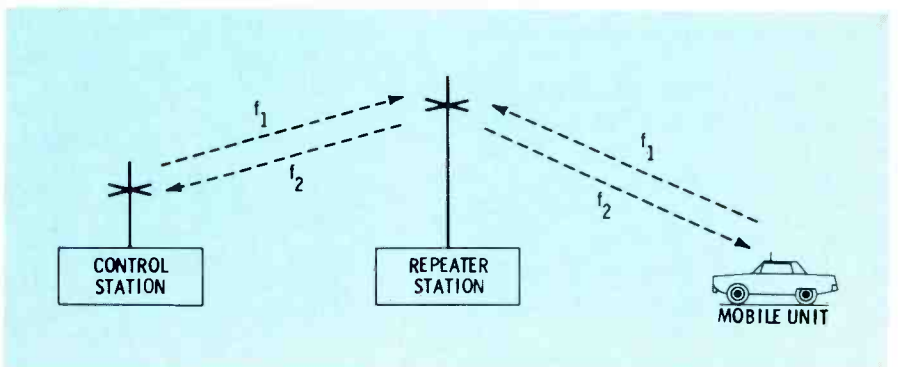

Fig. 8 Mobile radio relay system. Two frequencies are used on a simplex basis.

Warranties

The standard factory warranty covering mobile radio equipment is for 90 days, during which period defective parts will be exchanged by the factory. Some sets are covered by longer warranties, as long as two years. Since most parts are inexpensive, the factory warranty doesn't mean much to the service shop operator, except in the case of \$160 RF power transistors.

It is **your** warranty of your service that of concern to your customers. You can't afford to offer a full-coverage 90-day guarantee on every piece of equipment you service, and stay in business. You did not design nor manufacture the customers' equipment, and you can't assume responsibility for its overall durability, aside from the actual components you replace. What guarantee you offer will have to be based on your own feelings about the matter.

Getting Informed

To get into mobile radio servicing, you must get informed and keep informed about the subject. Besides reading **ELECTRONIC SERVICING**, you should also read **Communication News** (402 West Liberty Drive, Wheaton, Ill.), and, if you also intend to service CB equipment, you also should read **CB Magazine**. There are numerous books about mobile radio and CB, some of which were written by the author of this article. Also, you should get a set of Sams schematic manuals covering both mobile radio and CB.

To get a Second Class Radio Telephone Operator license, buy one of the question-and-answer license preparation books. To get a clearer picture of the whole mobile radio field, you can take one of several communications home study courses, or attend an electronics school that offers courses on servicing communications equipment. Some manufacturers conduct training programs for personnel employed by their authorized service stations.

Or, if you want to learn by doing, buy and build a CB transceiver kit or buy a second-hand FM mobile radio unit and start practicing.

Summary

Every radio-TV service shop operator should give serious consider-

ation to expanding into mobile radio. The demand for service is there, and growing fast.

Or, if you want to work for someone else, there are plenty of opportunities. Run an ad in **ELECTRONIC SERVICING**, **APCO Bulletin** (Box 669, New Smyrna Beach, Fla.), **Communications News** and **CB Magazine**; your phone will soon be ringing.

The beauty of mobile radio servicing is that you deal with other business men, not housewives, as in

TV. But, don't overlook CB. The customers vary from serious business men to what CBers call "ding-a-lings", or frustrated hobbyists. Since all CBers have invested from \$100 to several thousand dollars in equipment, they want to keep it operating. And, they'll pay you for it.

Parts 2 and 3 of this series will cover troubleshooting and proof-of-performance tests, respectively. ▲

*Carterfone Decision—An FCC ruling, made in 1969, which permits, in some radio services, the interconnection of a mobile radio system and the facilities of a telephone company.

Try these installations with any other five watt unit!

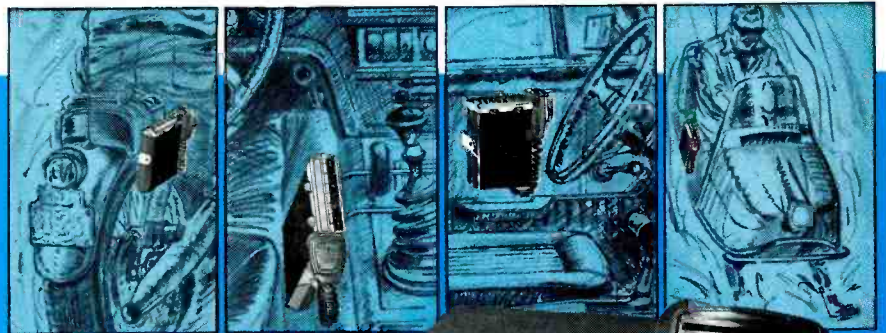

At \$99⁹⁵ the Messenger 125 fits anywhere ...including your budget.

Best of all, even with its mini-size and price, the Messenger 125 is *big* on performance. Its 5-watt transmitter, with high level class B modulation and speech compression, gives it all the "talk power" you'd expect from a full-size radio. Half-a-microvolt receiver sensitivity pulls in the weak ones. Automatic threshold noise limiting, IF clipping, and special AGC circuitry means less noise—better quieting. Full 2-watt audio lets you hear even in noisy vehicles. And the Messenger 125 looks great, too. Not a single knob—push-buttons select up to 5 channels, slide-levers adjust squelch and volume. Installs between bucket seats, in door pockets, on trail bikes—or over your shoulder with its optional rechargeable battery pack.



Dimensions: 1 $\frac{1}{16}$ " High x 4 $\frac{1}{32}$ " Wide x 7" Deep • 4-watts output at 13.8 VDC • FCC type accepted, DOC approved • All solid state—draws just 0.2 amperes on squelched stand-by • Optional portable pack available with rechargeable battery, charger, antenna, and leather carrying case



E. F. JOHNSON CO.
WASECA, MINN. 56093

Circle 27 on literature card

Aerovox Corp.	50
American Teelphone & Telegraph Co.	27
Bussmann Mfg. Div., McGraw-Edison Co.	6-7
C. R. T. Equipment Co.	53
Chemtronics, Inc.	Cover 2
Cleveland Institute of Electronics	9-11
General Electric Co.	64
Receiving Tubes	23
Heath Company	13
Jan Crystals	40
E. F. Johnson Co.	61
Littelfuse Inc.	Cover 4
Measurements	
A Div., McGraw-Edison Co. ...	60
Mosley Electronics, Inc.	4
RCA Parts and Accessories Cover 3	
RCA Sales Corp.	31
RMS Electronics	41
Raytheon Company	12
Sencore, Inc.	40, 41, 42, 43
Howard W. Sams & Co., Inc. ...	35
Sprague Products Company	3
Sylvania Electric Products Inc. 1, 21	
Telematic Div., U.X.L. Corp. ...	42
Tuner Service Corporation	5
Workman Electronic Products, Inc.	4
Xcelite, Inc.	63

TROUBLESHOOTING TIP?

If you've recently run across an unusual trouble symptom and have determined what caused it, pass the info on to other readers by sending it to:

Troubleshooting Tip,
Electronic Servicing
1014 Wyandotte Street,
Kansas City, Mo. 64105

When the troubleshooting tip is published, you will receive a check from ELECTRONIC SERVICING for sharing your servicing experiences with other readers.

product report

for further information on any of the following items, circle the associated number on the reader service card.

Solid-State Rectifier

Picture distortion resulting from low boost voltage caused by failing damper tubes in both black-and-white and color TV sets reportedly can be eliminated by a new Sarkes Tarzian rectifier. The solid-state, octal-based plug-in rectifier updates

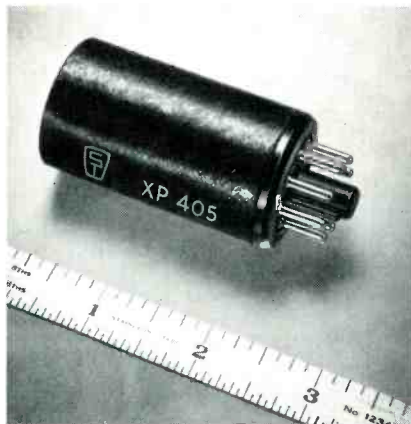

the set, directly replacing such damper tubes as the 6AX4 and 6AU4 types.

Electrical characteristics at 15.7 KHz include ratings of 5000 volts peak inverse voltage at 210 milliamps, with maximum peak current limit of 1300 milliamperes, according to the manufacturer. The maximum ambient temperature rating is 85°C (188°F). The unit is designed for parallel filament circuits only.

Designated Catalog Number XP405, the damper replacement sells to service dealers at \$6.60 each.

Circle 70 on literature card

Detection System

ACRO-GUARD, a completely self-contained ultrasonic intruder detection system, complete with automatic emergency phone dialing, is announced by Acron. According to the manufacturer, ACRO-GUARD's

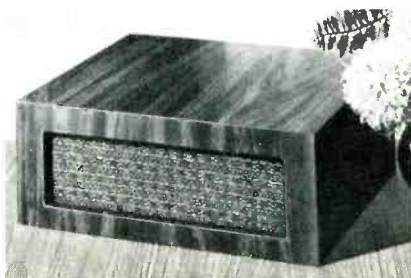

silent radar-like detectors, easily installed by any business owner, respond instantly to the presence of an intruder; then it automatically calls the police and anyone else you designate on the custom-programmed tape and delivers an emergency message.

Fire detection, as well as "panic buttons", bells, sirens, light switching and other signals, reportedly can be added to ACRO-GUARD.

The list price of this unit is \$495.

Circle 71 on literature card

Plotter Cart

The Technibilt Corp. has added to its equipment line the X-Y plotter cart, designed specifically for carrying electronic instruments. The 18-in. X 24-in. top deck may also be used to provide additional work space in shop or lab.

The carrier is built for maximum strength by using 16-gauge, 7/8-in.



steel tubing in the arc-welded frame, and 1-in. X 1-in. angle irons for rigid support, according to the manufacturer. The height of the cart from the floor to the handle is 35 inches. Optional features include a choice of deck coverings, utility drawer, side brakes and electrical outlet box.

Model 81554 is priced at \$69.50.

Circle 72 on literature card

Miniature Parts Tray

A miniature parts tray is now available from Contronic Devices.

The tray measures $\frac{5}{8}$ in. high by $15\frac{1}{2}$ in. wide by $7\frac{3}{4}$ in. deep, and has 65 cubicles, which are $\frac{3}{8}$ in. X $\frac{7}{8}$ in. X $1\frac{1}{8}$ in.

Made of high density polyethylene, the unit reportedly is resistant

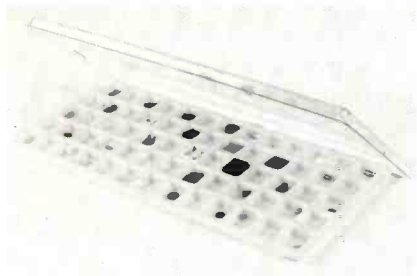

to M.E.K. acetone and freon, and will withstand temperatures up to 225°F for 3 hours.

The parts tray comes with a four-tab-snap clear cover. Prices range from \$4.75 each for quantities of 10-24 to \$4.00 each for quantities of 100-499.

Circle 73 on literature card

Aerosol Spray for Rust and Moisture Problems

To the electronics and aerospace fields comes Mitchell 12/34, by C. H. Mitchell Co. When sprayed upon any surface, the mixture penetrates corrosion, drives off moisture and



prevents either from forming for as long as two years. Mitchell is available in a 3 oz. can for \$1.00 and a 16 oz. can for \$2.35.

Circle 74 on literature card

Solid-State One-Gun Booster

A solid-state one-gun booster for color TV picture tubes has been announced by Workman Electronic Products, Inc.

The brightener boosts the color



of either the red, green or blue gun, balancing the color picture when only one color is weak. Self-stripping connectors are included in the package to aid in installation. The Model WG1 sells for \$5.10.

Circle 75 on literature card

Illuminated Magnifier

The "Clear Lite", an illuminated magnifier, is now available from INFO Inc. A $3\frac{1}{2}$ -in. X 6-in. optically ground lens with an 11-in. focal length provides undistorted, strain-free viewing ideally suited for extended work, according to the manufacturer. The adjustable arm permits the user to position the light precisely where needed. The lens can be tilted independently.

The Clear Lite comes equipped with twin 4-watt fluorescent lamps



which provide up to 500 foot candles of uniform, shadowless illumination, it is reported. The light is priced at \$69.00. ▲

Circle 76 on literature card



nutdriver set

with Locknut/Screw adjusting feature

Speeds, simplifies setting of combination locknut/slotted screw adjustments on rheostats and similar controls used in a wide variety of electrical and electronic equipment.

Handle is drilled so you can run an 8" screwdriver blade right through its center and down through the hollow nutdriver shaft.



Ideal for all-around production, maintenance, and service work, this new HSC-1 Set contains eight interchangeable hollow nutdriver shafts in the most popular hex opening sizes from $3/16$ " thru $9/16$ "



Really compact! Set is small enough, light enough to carry in your hip pocket. Sturdy, see-thru, plastic carrying case doubles as a bench stand.

WRITE FOR BULLETIN N867



XCELITE, INC., 18 Bank St., Orchard Park, N. Y. 14127
In Canada contact Charles W. Pointon, Ltd.

Circle 28 on literature card

power transistors



when you think
of power, think of

GE

**SEMICONDUCTOR
REPLACEMENTS.**

For universal replacements, specify:

TYPE	WATTS	TYPE	WATTS
GE 3	25	24 MP	15
4	50	25	56
12	10	26	20
13 MP	25	27	6
14	115	28	12
15 MP	115	29	12
16	90	30	6
19	90	31 MP	6
23	15		

a few will do

TUBE DEPARTMENT
OWENSBORO, KENTUCKY

GENERAL  ELECTRIC

Circle 29 on literature card

catalogs literature

ANTENNAS

100. *Hy-Gain Electronics Corp.*—has published Catalog J, a 4-page, 3-color illustrated catalog covering 13 of the company's line of marine antennas and mounting hardware.
101. *New-Tronics Corp.*—has released three new catalogs: an illustrated, 20-page catalog covering their line of Citizens-Band antennas; an illustrated, 8-page Hustler Ham catalog covering the company's line of fixed station, mobile, high-frequency and VHF and UHF antennas and accessories; and a 6-page catalog covering Newport auto antennas.

AUDIO

102. *Russell Industries, Inc.*—announces the availability of a 4-page, illustrated catalog of retractable cords, featuring power cords, prepared cords, test leads, miniature cords and communications cords, and including specifications and prices.

COMPONENTS

103. *Cornell-Dubilier Electronics*—has released three new catalogs: a 120-page third edition of the company's Component Selector, covering CDE's SPRINT program, a system of product standardization, and listing all standard items stocked; a revised technical bulletin for sub-miniature aluminum electrolytics; and a 2-page bulletin on their new line of RFI/EMI filters.
104. *International Rectifier, Semiconductor Div.*—has issued two new pieces of literature: a "Handy Pocket Cross Reference", covering IR's line of universal replacement transistors and

universal rectifiers; and a 40-page, illustrated "Selenium Rectifiers and Transient Suppressors", Engineering Brochure No. B-108, outlining IR's line of selenium rectifiers, Klip-Sel transient voltage suppressors and contact protectors.

105. *Triplet Corp.*—A new 20-page Catalog No. D-70 covers Triplet's line of standard and special panel meters and includes detailed electrical and mechanical specifications and dimensional and mounting drawings.
106. *Birnbach Co.*—announces Catalog No. 2570, a 24-page, illustrated booklet covering their line of wire, cable, tubing and hardware.

SERVICE AIDS

107. *Chemtronics Inc.*—has made available two new illustrated booklets: "TUN-O-FOAM TECH TIPS" explains possible uses for TUN-O-FOAM spray lubricant/cleaner; and "HOW TO SPEED SERVICING WITH TUN-O-WASH" covers the use of this aerosol cleaner/degreaser.*

SPECIAL EQUIPMENT

108. *General Electric Co.*—has issued a 2-page Bulletin No. GEA-8114A, which describes GE's line of plug-in Volt-Pac variable transformers for shop applications requiring adjustable AC voltage. Volt-Pac units are available in 120- or 240-volt models.*

TECHNICAL PUBLICATIONS

109. *Howard W. Sams & Co., Inc.*—Literature describes popular and informative publications on radio and TV servicing, communication, audio, hi-fi and industrial electronics, including 1970 catalog of technical books on every phase of electronics.*

*Check "Index to Advertisers" for additional information. ▲

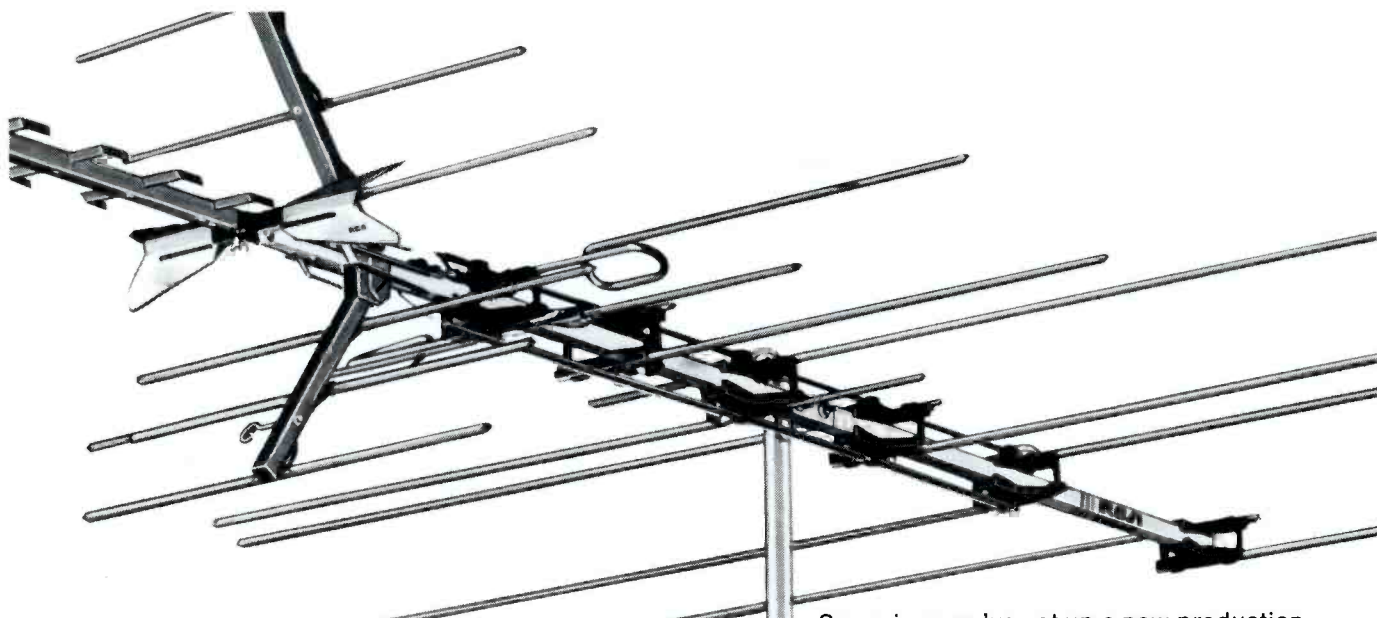

The new Permacolor antenna from RCA has:

“Permanent” element/ feed line connections.

Polypropylene insulators that pivot.

An integrated bow tie.

Square boom.

Tough vinyl finish.

That ought to prove RCA is serious about the antenna business.

So serious we've set up a new production facility at RCA's Memphis, Tennessee plant. But before we manufactured a single antenna, our engineers literally started designing from scratch. The result? A high performance, long lasting antenna.

Here are just a few reasons why RCA Permacolor antennas are different, and are an improvement over what you're now selling.

1. Permanent connections. Elements and feed lines are solidly connected by riveted aluminum straps. This reduces reception failure due to flimsy connections.
2. Perma-tuned circuits. All active elements (many perform more than one function) are permanently connected to a symmetrical aluminum feed line.
3. “Single unit” insulator/element. Insulators are polypropylene. Elements are assembled 5½ inches right into the insulators. Elements and insulators pivot as a unit—lock in place—have no loose connections. And no high stress points along the entire assembly.
4. Bow tie and 110° corner reflector UHF Section. For the first time, a bow tie/corner reflector UHF antenna is integrated into a single downlead all channel antenna. The result: better UHF and VHF reception.
5. One-piece construction. Simply open up and install. Permacolor antennas go up in one piece on the roof. Not on the ground. No bag of bolts. Nothing to take apart and reassemble. Snap-off elements let you quickly tailor the antenna to local conditions.
6. Tough blue and gold vinyl finish on all aluminum parts protects against weather and airborne chemicals.

The new RCA Permacolor Antenna is the antenna you can put up for good. See it now at your RCA Parts and Accessories distributor.

Parts and Accessories, Deptford, N.J.

RCA

Circle 33 on literature card

THE SAFEST SETS YOU'LL EVER SERVICE HAVE LITTELFUSE CIRCUIT BREAKERS.



Standard Catalog Part No.	Hold Rating (Amps.)	Standard Catalog Part No.	Hold Rating (Amps.)
815.650	.490	8152.75	1.92
815.800	.600	815003	2.1
815001	.650	8153.25	2.2
8151.25	.930	815004	2.5
81501.5	1	81504.5	3
8151.75	1.2	8*5005	3.25
815002	1.4	8*5006	3.9
8152.25	1.5	8*5007	4.14
81502.5	1.65		

Littelfuse TV set circuit breakers are the safe, reliable, money saving short-circuit-problem-solvers . . . 17 available models—exact replacements—cover the entire range of domestic television sets.

Littelfuse circuit breakers are available from your distributor—singly or in bulk.

Super-simple in operation—the sensitive breaker flips open under current overloads protecting the circuitry. Reset by merely pressing the red reset plunger. A built-in "trip free" feature of Littelfuse breakers prevents forced closing when dangerous overload currents are present.

Nothing's more reliable than a Littelfuse circuit breaker. Thermal-responsive Littelfuse breakers are dual operated bi-metallic devices providing temperature compensation over a wide range of ambient temperature variation. Molded phenolic construction eliminates warping and distortion of the base, maintaining exact factory set calibrations. The unit is completely enclosed to protect critical moving parts from dirt and other foreign matter.

Any TV set you're likely to service will take Littelfuse circuit breakers.

They'll flip for safety.

You'll flip for satisfaction.

LITTELFUSE

DES PLAINES, ILLINOIS 60016

SUBSIDIARY OF TRACOR, INC.
Circle 2 on literature card